



**Powered By
Certified LED Lights**

Specializing in Value Engineered Fixtures of the Highest Quality, Certifications & Warranty

2026

TABLE OF CONTENT

Indoor

Pendant Light / Architectural Strip Light	Page 3-4
Architectural Downlight.....	Page 5
Center Basket Troffer / Flat Panels.....	Page 6-7
Downlights.....	Page 8-11
Emergency / Exit	Page 12-15
Emergency Drivers	Page 16-17
High Bays	Page 18-19
Linear Strips	Page 20
Rope Light	Page 21
Tape Light / Modules / Channels.....	Page 22-24
12V Drivers / 24V Drivers.....	Page 25
Tubes Lights.....	Page 26-27
Under Cabinet	Page 28
Vapor Tight.....	Page 29-30
Wrap Light.....	Page 31

Outdoor

Bullet Light.....	Page 32
MPAL Flood Light CCT.....	Page 33
AL2 Area Light CCT / Legacy 2 Area Light CCT	Page 34-35
Canopy Light	Page 36
Gooseneck Barn Light / Bollard.....	Page 37
Top Post Light	Page 38
Sports Lights.....	Page 39
Wall Packs	Page 40-44

Accessories

Switches / Plugs / Devices	Page 45
Controls	Page 46
Photocells / AMT Sensor	Page 47
Installation Hardware	Page 48-51
Poles	Page 52-54
Conversion Chart.....	Page 55



This pendant light is a versatile, modern LED cylinder light designed for both indoor and outdoor use. It features a streamlined cylinder design with a durable die-cast aluminum housing and a PC (polycarbonate) lens. The robust construction makes it suitable for perimeter and area lighting in various locations. The light is highly versatile and can be installed in surface mounted and pendant-hung applications. The light offers field-adjustable settings via internal switches, allowing customization for specific lighting needs. A switch allows users to select between four color temperatures: 2700K, 3000K, 3500K, and 4000K. Users can choose from three different wattage levels: 21W, 28W, and 35W. The beam angle can be adjusted from 30 to 60 degrees.

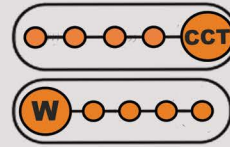

Field Selectable 4 CCT dip switch:
2.7K, 3K, 3.5K, 4K

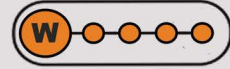

Field Selectable wattage dip switch:
21W, 28W, 35W

- * UL Listed
- * Damp location rated
- * 5-year warranty on all electronics and housing



- * Tunable CCT 2.7K, 3K, 3.5K and 4K
- * Wattage selectable: 21W, 28W, 35W
- * 80 to 99 lumens per watt
- * Weled Power Driver - COB LED
- * 0-10V dimming standard: Output constant current lever can be adjusted through output cable
- * Long-life LEDs provide 50,000 hours of operation
- * Universal 120-347 AC voltage (50-60Hz) is standard
- * Power factor > 0.90
- * Working temperature : -40 F - 122 F
- * Beam Angle: adjustable (30 /40 /50 /60)
- * Total harmonic distortion < 20%
- * Color rendering index > 80
- * Die cast aluminum housing with dark black, powder coat finish.
- * PC lens.
- * Easy installation for new construction or retrofit
- * Wet-location rated, ideal for bathrooms, laundry, porches and garage work rooms.

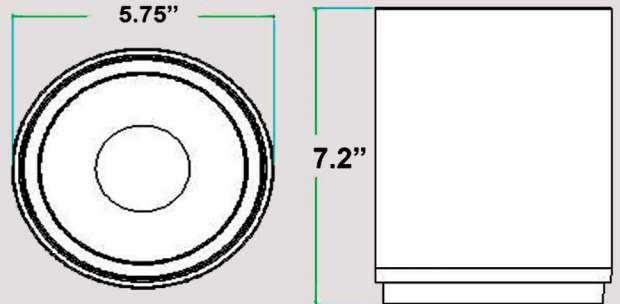

* This light come standard with a 12FT of black SO cord and connectors so it can be hung like a pendant. It can also be surface mounted.

PART #	CCT Color Temp	Lumens	Selectable wattage	Voltage
CLD01-35WXYC1	2.7K, 3K, 3.5K, 4K	1,680 – 3,465	21W, 28W, 35W	120-277V



This architectural direct / indirect linear strip light is a decorative commercial grade fixture. It offers both wattage and kelvin selectability with several adjustments to set the direct/ indirect light as needed. Designed to be linkable and support multiple mounting solutions (10ft cable kit with canopy plates is standard). Perfect for offices, retail, and other hospitality spaces.

- * CCT selectable in 3500K, 4000K, 5000K
- * Wattage selectable 30W, 40W, 50W (4Ft) and 50W, 64W, 80W (8Ft)
- * Long-life LEDs provide 100,000 hours of operation
- * 115 lu/W LEDs
- * 0-10V dimming capability
- * Universal 120-277 AC voltage (50-60Hz) is standard
- * Power factor > 0.90
- * Beam angle: 120 degrees
- * Color rendering index > 80
- * Available in white only. White 10ft S.O cord
- * Adjustable direct / indirect flux ratio:
direct: 100%, 70%, 50% ; indirect: 0%, 30%, 50%

Adjustable flux ratio



CCT Selectable
3500K, 4000K, 5000k

Wattage Selectable
30W, 40W, 50W (4Ft)
50W, 64W, 80W (8Ft)



Canopy plate and 10' cable included with light

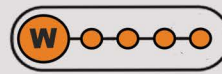

Field Selectable wattage dip switch:
30, 40, 50W for the 4ft
50, 64, 80W for the 8ft

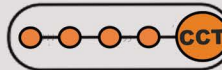

Field Selectable CCT dip switch:
3.5K, 4K, 5K

- * UL Listed
- * DLC listed
- * Damp Rated
- * 5-year warranty

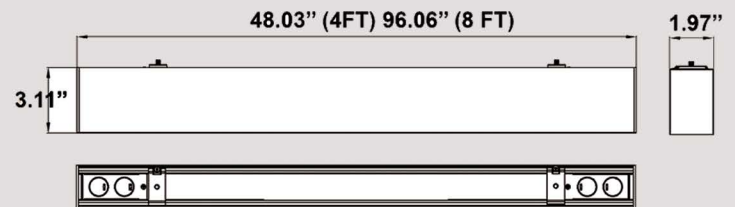

1 piece straight joiner + piece portional bracket + 8 screws

ACCESSORIES	Order Separately	
AS1-4FT-Recessed-Kit	AS1 recessed frame kit only compatible with 4FT fixture recessing into hard ceiling	
AS1-Surface Mount Kit	Used to surface mount AS1 fixtures on hard ceilings	
AS1-Joiner	Straight shape connector used to join 2 lights to make straight runs	
LR42622	90 degree connector to join AS1 to make "L" shapes, square and rectangles	
LR42672	Bi-Level motion sensor that goes on the end of an AS1	

PART #	Size	Color Temp	Lumens	Lumen/Watt	Wattage	Emergency Driver
AS1-4FT50W-L-TCP	4Ft	3.5K, 4K, 5K	3450,4600,5750	115	30/40/50	
AS1-4FT50W-L-TCP-EM	4Ft	3.5K, 4K, 5K	3450,4600,5750	115	30/40/50	EM Installed
AS1-8FT80W-L-TCP	8Ft	3.5K, 4K, 5K	5750,7360,9200	115	50/64/80	
AS1-8FT80W-L-TCP-EM	8Ft	3.5K, 4K, 5K	5750,7360,9200	115	50/64/80	EM Installed



The 4", 6", 8" and 10" Architectural downlights are a recessed retrofit solution that has an integrated LED power supply which springs install directly in the ceiling without a housing. This high-efficacy fixture provides long-life and uniform illumination as well as a (Dual-Mode) MAGIC driver model offering both Triac dimmable @ 120V and 0-10V @ 277V dimmable (except 10" is 0-10V only). All sizes come with a 5 year warranty. Each light is wattage and 5 CCT 2.7K, 3K, 3.5K, 4K and 5K selectable to fit most needs. It is the perfect choice for both new construction and retrofits making it ideal for offices, schools, hospitals, and other indoor spaces. ETL Listed for wet locations, this light is ideal for indoor and outdoor applications.

- * Wattage selectable: 6W, 9W, 12W (4"); 12W, 17W, 22W (6") 17W, 24W, 30W (8"); 26W, 30W, 35W, 40W, 45W (10")
- * CCT selectable: 2.7K, 3K, 3.5K, 4K, 5K
- * Universal voltage AC120V-277V. 50 - 60Hz
- * Power factor > 0.90 - THD < 20% - CRI > 80
- * Viewing angle: 100
- * Compatible w/ most architectural housings or frames
- * Triac dimming capability is standard. Compatible with most triac dimmers to give user a smooth 100%-10% dimming to choose the desired brightness. Standard with a (Dual- Mode) MAGIC driver model offering both Triac dimmable @ 120V and 0-10V @ 277V dimmable. 10" light is 0-10V only
- * Designed with integral whip to connect directly to a junction box; Ideal for installation into existing CFL pin-based fixture infrastructure

Housing

- * High quality Aluminium shell with frosted PC diffuser



- * ETL Listed for wet locations (except 10")
- * California Title 24 - JA8-2022-E
- * IC rated for direct contact with insulation
- * Operating temperatures from -4°F to 104°F
- * Five year warranty

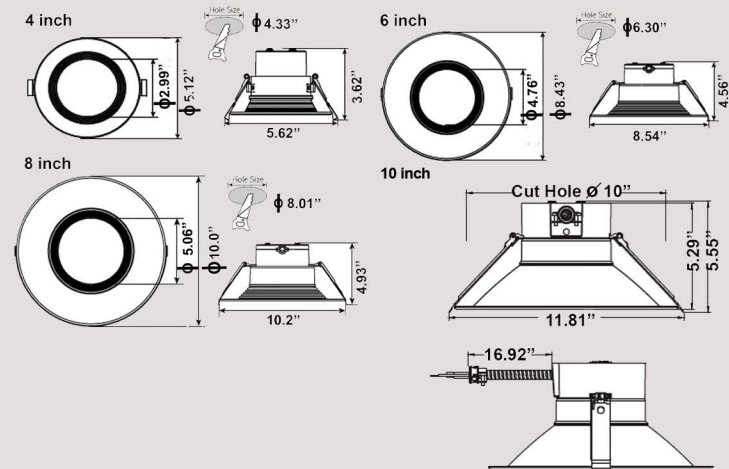

Mounting

- * The adjustable housing clips allow for installation in a large range of commercial and architectural housings. These spring-action clips push up easily and provide a secure fit for both retrofit and new construction applications.

PART#	LUMENS	WATTS SELECTABLE	LM/W	CCT COLOR TEMPS
4CMCT12LR05	704 TO 1285	6, 9, 12	106 -111	2.7K, 3K, 3.5K, 4K, 5K
6CMCT22LR05	1240 TO 2349	12, 17, 22	98 - 119	2.7K, 3K, 3.5K, 4K, 5K
8CMCT30LR05	1859 TO 3270	17, 24, 30	105 - 126	2.7K, 3K, 3.5K, 4K, 5K
10CDL45W-5CW	3380 TO 5390	26, 30, 35, 40, 45	130 - 138	2.7K, 3K, 3.5K, 4K, 5K



These 2' x 2' and 2' x 4' LED Center Basket Volumetric Troffers are designed as a direct replacement for fluorescent fixtures installed in ACT grid or gyp. ceilings. These fixtures are kelvin selectable 3K, 3.5K, 4K, 5K, 6K and wattage selectable. It is the perfect choice for both new construction and retrofits. This high-efficacy fixture provides long-life and uniform illumination as well as standard 0-10V dimming capability. This panels Series uses dip-switches to switch between five wattage and 5 CCT ranges making it ideal for offices, schools, hospitals, and other indoor spaces.

- * 137 to 162 Lumens per watt
- * Lumens: 2x2 : 2920 - 6027 / 2x4 : 3725 - 7533
- * Long-life LEDs provide 50,000 hours of operation with at least 70% of initial lumen output (L70)
- * Universal 100-277 AC voltage (50-60Hz) is standard
- * 0-10 V dimming capability is standard
- * Power factor > 0.90 and CRI > 80
- * Viewing angle: 120°
- * Easy installation in new construction or retrofit
- * Standard earthquake clips provide secure installation in grid ceilings
- * Factory installed Emergency backup available.
- * Operating temperatures from -4°F to 120°F

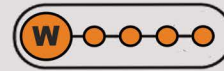

Field Selectable wattage dip switch:
20, 25, 30, 35, 40W for the 2x2 Troffer
25, 30, 40, 45, 50W for the 2x4 Troffer

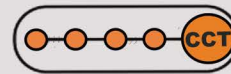

Field Selectable CCT dip switch:
3K, 3.5K, 4K, 5K, 6K

- * ETL Listed
- * DLC 5.1 Premium listed
- * FCC Part 15, class B
- * Damp location

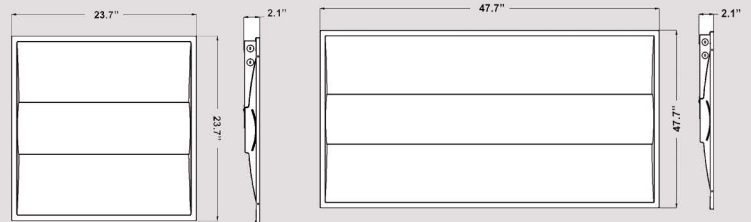

Accessories Sold Separately

CATEGORY	PART #	DESCRIPTION	NOTE
Surface Mounting Kit	SMKT-22	Surface Mount Kit for 2x2 Panels	Order Separately
	SMKT-24	Surface Mount Kit for 2x4 Panels	Order Separately
Recessed Flange Kit	22RFKIT-W	Recessed Flange Kit for 2x2 Panels	Order Separately
	24RFKIT-W	Recessed Flange Kit for 2x4 Panels	Order Separately

PART #	Lumens	Wattage selectable	CCT Tunable	EM Driver	
22TRF-40S5-27-TCP	2920-6027	20,25,30,35,40W	3K,3.5K, 4K, 5K, 60K		
24TRF-50S5-27-TCP	3725-7533	25,30,40,45,50W	3K,3.5K, 4K, 5K, 60K		
22TRF-40S5-27-TCP-EM	2920-6027	20,25,30,35,40W	3K,3.5K, 4K, 5K, 60K	HM08D-8W	Factory installed
24TRF-50S5-27-TCP-EM	3725-7533	25,30,40,45,50W	3K,3.5K, 4K, 5K, 60K	HM08D-8W	Factory installed

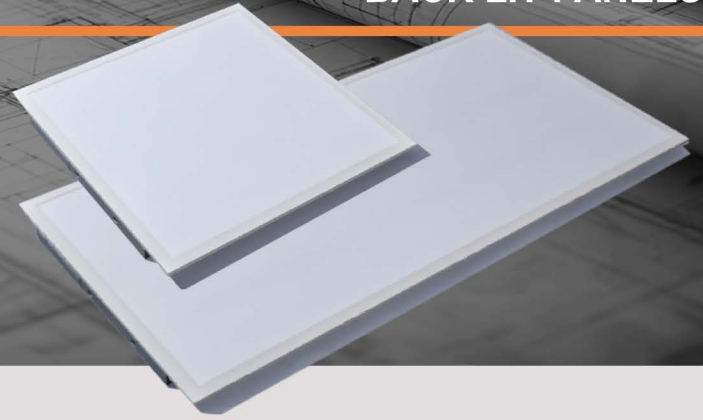

These Back-Lit LED Panels are designed to deliver general ambient lighting in a variety of indoor settings including schools, offices, hospitals, stores, and are the perfect choice for both new construction and retrofits. This high-efficacy fixture is 5 CCT and power tunable as well as standard 0-10 V dimmable.

- * 110 to 132 Lumens per watt
- * Lumens: 1x4: 2760-3910 / 2x2: 2200 - 4400 / 2x4: 3736 - 8341
- * Long-life LEDs provide 50,000 hours of operation with at least 70% of initial lumen output (L70)
- * Universal 100-277 AC voltage (50-60Hz) is standard
- * 0-10 V dimming capability is standard
- * Power factor > 0.90 and CRI > 80
- * Viewing angle: 120° - 113° 1 x 4 panel
- * Easy installation in new construction or retrofit
- * Standard earthquake clips provide secure installation in grid ceilings
- * Factory installed Emergency backup available
- * Operating temperatures from -4°F to 120°F

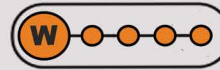

Field Selectable wattage dip switch:
 15, 20, 25, 30, 40W for the 1x4 panel
 20, 25, 30, 35, 40W for the 2x2 panel
 30, 40, 50, 60, 72W for the 2x4 panel

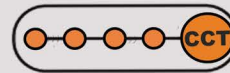

Field Selectable CCT dip switch:
 3.5K, 4K, 5K, 5.7K, 6.5K for the 1x4 panel
 3K, 3.5K, 4K, 5K, 6K for 2x2 and 2x4

- * ETL Listed
- * DLC Premium listed
- * FCC Part 15, class B
- * Damp location



- * Dimensions 1x4 panel: 11.9" x 47.8" x 1.67
- * Dimensions 2x2 panel: 23.81" x 23.81" x 1.31" (2.5" with EM installed)
- * Dimensions 2x4 panel: 47.81" x 23.81" x 1.31" (2.5" with EM installed)

CATEGORY	PART #	DESCRIPTION	NOTE
Surface Mounting Kit	SMKT-14	Surface Mount Kit for 1x4 Panels	Order Separately
Surface Mounting Kit	SMKT-22	Surface Mount Kit for 2x2 Panels	Order Separately
Surface Mounting Kit	SMKT-24	Surface Mount Kit for 2x2 Panels	Order Separately
Recessed Flange Kit	14RFKIT-W	Recessed Flange Kit for 1x4 Panels	Order Separately
Recessed Flange Kit	22RFKIT-W	Recessed Flange Kit for 2x2 Panels	Order Separately
Recessed Flange Kit	24RFKIT-W	Recessed Flange Kit for 2x4 Panels	Order Separately

PART #	Lumens	Wattage Selectable	CCT Tunable	EM Driver	
NC-BPL14-M40W-CCT	2760 – 3910	15, 20, 25, 30,40W	3.5K, 4K, 5K, 5.7K, 6.5K	HM08D-8W	Order Separately
22BPANEL-40W-27-5TCP	2280 – 4800	20, 25, 30, 35, 40W	3K, 3.5K, 4K, 5K, 6K		
24BPANEL-72W-27-5TCP	3420 – 8640	30, 40, 50, 60, 72W	3K, 3.5K, 4K, 5K, 6K		
22BPANEL-40W-27-5TCP-EM	2280 – 4800	20, 25, 30, 35, 40W	3K, 3.5K, 4K, 5K, 6K	HM08D-8W	Factory Installed
24BPANEL-72W-27-5TCP-EM	3420 – 8640	30, 40, 50, 60, 72W	3K, 3.5K, 4K, 5K, 6K	HM15D-15W	Factory Installed



Illuminate your space with the advanced 360° Round Gimbal Recessed Downlight, featuring a versatile 5CCT color temperature selection. This innovative lighting solution allows you to effortlessly tailor your ambiance, offering a selection of warm white to cool daylight tones to suit any mood or occasion. The directional design enables a remarkable tilt of 30°, along with a full 360° rotation, allowing you to focus light precisely where it's needed. Equipped with a powerful 38° beam angle and a high-precision lens, this downlight delivers exceptional clarity and vibrant color rendition. Experience uniform brightness that eliminates the risk of scattering or glare, ensuring your interiors are bathed in soft, inviting light. Perfect for residential or commercial settings, this downlight combines functionality with sophistication, enhancing both aesthetics and comfort in any environment. Triac dimming capability is standard. This downlight comes with a 5 year warranty.

- * CCT: 5 color temperature selectable in the field
- * 79 to 85 lumens per watt (2 inch)
- * 71 to 88 lumens per watt (3 inch)
- * 71 to 82 lumens per watt (4 inch)
- * Long-life LEDs provide 50,000 hours of operation
- * 120V input standard
- * Triac dimming capability is standard. Compatible with most triac dimmers to give user a smooth 100%-10% dimming to choose the desired brightness.
- * Aluminum die-cast body with adjustable gimbal
- * Spring loaded retention arms allow for easy installation into ceilings with no need for a recessed hole
- * TIR optic provides smooth, uniform light with a 38° beam angle
- * Power factor > 0.90 - THD < 20% - CRI > 90
- * Easy installation in new construction or retrofit. No existing recessed housing or junction box required. Install J-Box in ceiling beam, and insert light right into drywall opening

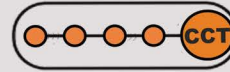

Field Selectable CCT dip switch:
2.7K, 3K, 3.5K, 4K, 5K

- * ETL Listed for wet locations
- * Energy Star
- * Title 24 - JA8-2022-E
- * IC rated for direct contact with insulation
- * Operating temperatures from -4°F to 113°F
- * 5-yr warranty



2 Inch: 2 1/8" hole cutout

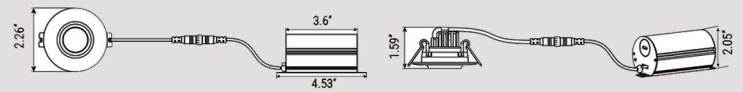

3 Inch: 2 3/4" hole cutout

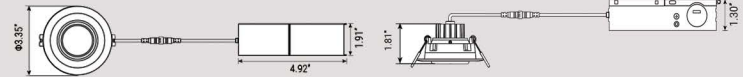

4 Inch: 4 1/4" hole cutout

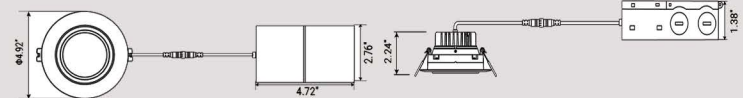

38° Beam Angle



30° Tilt Range



360° Rotation



PART #	Description	Kelvin Selectable	Lumens	Wattage
2EJCT05WRWH	2" LED Gimbal Light	2.7K, 3K, 3.5K, 4K, 5K	396 TO 408 Lm	5W
3EJCT08WRWH	3" LED Gimbal Light	2.7K, 3K, 3.5K, 4K, 5K	573 to 654Lm	8W
4EJCT12WRWH	4" LED Gimbal Light	2.7K, 3K, 3.5K, 4K, 5K	861 to 978 Lm	12W



These highly versatile and energy-efficient lights are a great choice for residential and commercial spaces, offering both an aesthetic appeal and functional versatility with a lamp thickness of 0.39-inch. The recessed slim wafer is IC and wet location rated, making them suitable for installation with direct contact to insulation and in areas exposed to moisture. This includes insulated ceilings, bathrooms, laundry rooms, porches, and garage workspaces. Offered in both 4-inch and 6-inch sizes with color tunable technology, allowing users to choose from a range of temperatures including 2700K (warm white), 3000K (soft white), 3500K (neutral white), 4000K (cool white), and 5000K (daylight). Magic Duel Mode is available on the 6-inch model with 0-10V dimming capability @ 277V and Triac dimmable @ 120V. This light comes with a 5 year warranty.

- * CCT: 5 color temperature selectable in the field: 2.7K, 3K, 3.5K, 4K, 5K
- * 64 to 76 lumens per watt (4 inch)
- * 81 to 96 lumens per watt (6 inch)
- * Power factor > 0.90 - THD < 20% - CRI > 90
- * Viewing angle: 100 degrees
- * Long-life LEDs provide 50,000 hours of operation
- * 120V input is standard. Universal 100-277 AC voltage (50-60Hz) is available on 6" magic
- * Triac dimming capability is standard. Compatible with most triac dimmers to give user a smooth 100%-10% dimming to choose the desired brightness. 6" DM (Dual-Mode) driver model offers both triac dimmable @ 120V and 0-10V @ 277V dimmable.
- * Wet-location rated, ideal for bathrooms, laundry, porches and garage work rooms.
- * Edge-lit technology, with no glare or dark spots
- * Easy installation in new construction or retrofit. No existing recessed housing or junction box required. Install J-Box in ceiling beam, and insert light right into drywall opening.

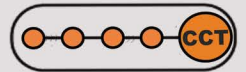
 Field Selectable CCT 5 dip switch:
2.7k, 3K, 3.5k, 4K, 5K

- * ETL listed for wet location
- * Title 24 - JA8-2022-E
- * IC Rated for direct contact with insulation
- * Operating temperatures from -4°F to 113°F
- * Energy Star
- * 5-yr warranty



4" light

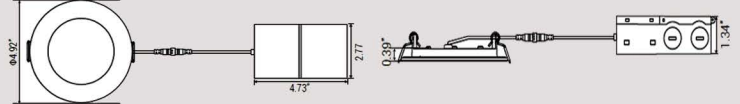

6" light

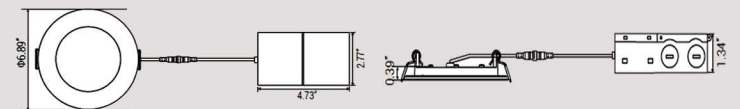

SIZE	HOLE SIZE
4inch	4 21/64"
6inch	6 19/64"

4" and 6": Easy switch for desired CCT

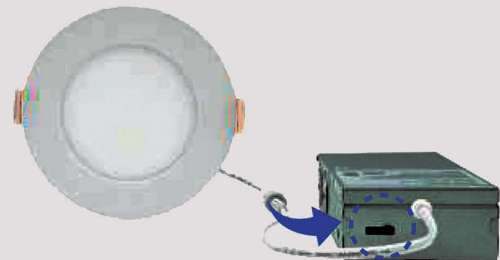

PART #	Description	Kelvin Selectable	Lumens	Energy used
4EJCT09SR05	4" Triac Dimmable	2.7K, 3K, 3.5K, 4K, 5K	619 TO 701 Lm	9W
6EJCT12SR05	6" Triac Dimmable	2.7K, 3K, 3.5K, 4K, 5K	957 to 1010 Lm	12W
6EJCT12SR05-MAGIC	6" Dual Mode Driver	2.7K, 3K, 3.5K, 4K, 5K	957 to 1010 Lm	12W

SURFACE MOUNT DOWNLIGHT



6" CCT DISK LIGHT



Field Selectable dip switch:

- * Color Temperature: 3CCT 15W: 3K, 4K, 5K
- * Junction Box Complies to ETL Safety Standard
- * High Lumens Output: 1100
- * 120VAC
- * Triac dimmable
- * Surface mount
- * CRI: >90
- * 90 degree beam angle
- * Power Factor: 0.9
- * Lifetime: 50,000 hours
- * Working temperature: -4 F to 140F
- * Easy Installation, labor Cost Saving

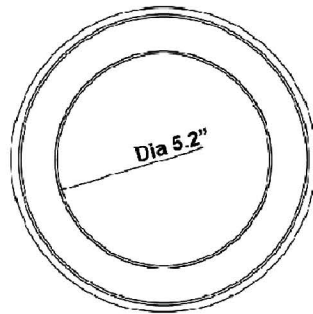
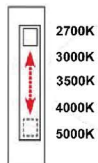
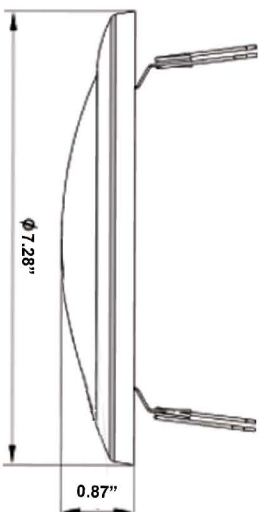

PART#	LUMENS	WATTS	LUMEN /WATT	CCT COLOR TEMPS
EPDL00410701	1,100	15	73	3K, 4K, 5K

SURFACE MOUNT DOWNLIGHT 15W and 21W

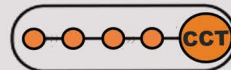

Field Selectable 5 CCT dip switch:

- * 5 CCT Selectable: 2.7K, 3K, 3.5K, 4K, 5K
- * Wattage: 15W (7") and 21W (11")
- * 66 to 85 lu/w (7 inch) - 75 to 89 lu/w (11 inch)
- * High lumen output: 1,275 (7") - 1869 (11")
- * 120VAC 60Hz
- * Triac dimming capability is standard. Compatible with most triac dimmers to give user a smooth 100%-10%
- * Beam angle: 120 degrees
- * CRI: > 80 - Power factor: 0.9
- * Finish: white
- * Ultra bright LED Flush Mount is only 0.79" (7") 0.98 (11") thickness
- * 5 year warranty



Field selectable CCT 5-way switch: 2.7K, 3K, 3.5K, 4K, 5K

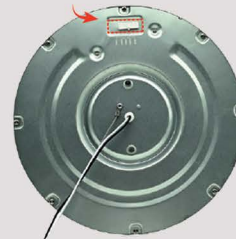

7" Surface Mount

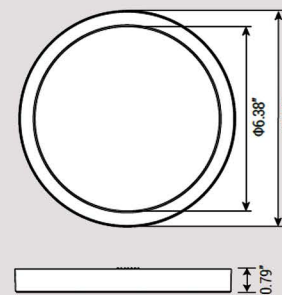

11" Surface Mount

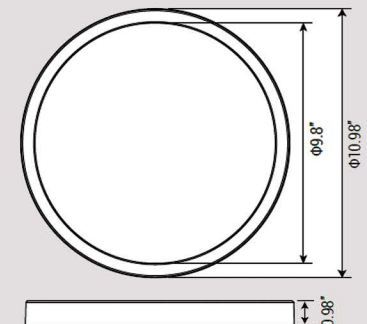

PART #	Size	Kelvin Selectable	Lumens	Energy used
7FMCT15URWH	7"	2.7K, 3K, 3.5K, 4K, 5K	949 to 1135 Lm	15W
11FMCT21URWH	11"	2.7K, 3K, 3.5K, 4K, 5K	1582 to 1862 Lm	21W



4" & 6" RETROFIT TRIM DOWNLIGHT XHVCTXXLRWH

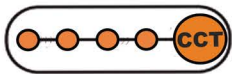

Field Selectable 5 CCT dip switch:
2.7K, 3K, 3.5K, 4K, 5K

- * Color temperature: 2.7K, 3K, 3.5K, 4K or 5K selectable
- * 71 to 82 lu/w (4 inch) - 68 to 79 lu/w (6 inch)
- * Long-life LEDs provide 50,000 hours of operation
- * 120V input is standard
- * Power factor > 0.90 - THD < 20% - CRI > 90
- * Triac dimming capability is standard. Compatible with most triac dimmers to give user a smooth 100%-5%
- * Wet-location rated, for new and old construction, remodels, soffit, eaves, shower, etc.
- * Step Baffle / Smooth Trim
- * Viewing angle: 100 degrees
- * Retrofits in existing incandescent can housing
- * Easy installation with universal E26 connectors. Fits 4", 6" compatible housings. E26 screw base adapter connects directly to standard socket
- * Compatible with insulated, non-insulated and air-tight ceilings.
- * 5-year warranty



4" Retrofit Downlight

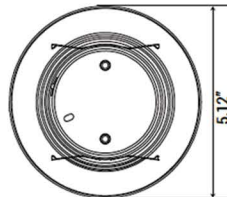

6" Retrofit Downlight

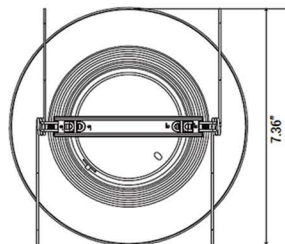
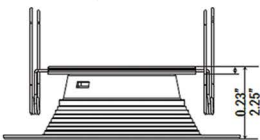

PART #	Size	Kelvin selectable	Lumens	Energy used
4HVCT10LRWH	4"	2.7K, 3K, 3.5K, 4K, 5K	768 to 909 Lm	10W
6HVCT15LRWH	6"	2.7K, 3K, 3.5K, 4K, 5K	1011 to 1245 Lm	15W

6" DISK LIGHT WITH PIR D556-CCT-MS (Motion Sensor)

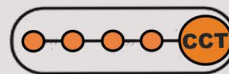

Field Selectable 5 CCT dip switch:
2.7K, 3K, 3.5K, 4K, 5K

- * 15W, 1100 Lumens, 5CCT 2.7K, 3K, 3.5K 4K, 5K
- * Long life LED's with up to 50,000 hours at 70% lumen maintenance
- * PIR motion sensor activates light, 5 min no motion deactivates to conserve energy
- * Beam angle: 113 degrees
- * High efficiency driver with a power with factor >0.90 with input power of 120V AC, 50 - 60Hz
- * Operation temperature of -4F - 104F
- * No housing required
- * ETL Listed - Wet rated
- * Energy Star
- * 5-year warranty on all electronics and housing

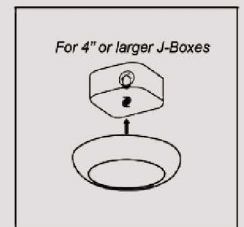
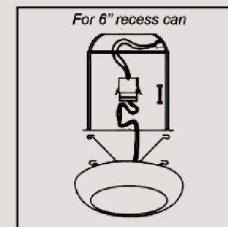
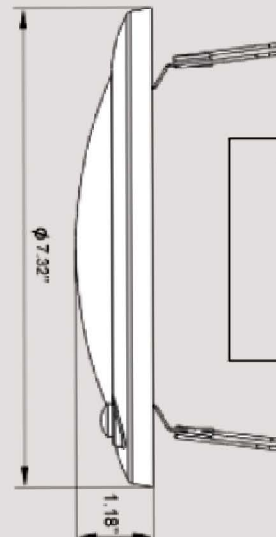

PART #	CCT Color Temp	Wattage	Lumens
D556-CCT-MS	2.7K, 3K, 3.5K, 4K, 5K	15	1100

EMERGENCY EXIT



EXTSGN Thermoplastic Exit Sign

- * Ultra bright, energy efficient, long life Red LED's on white or black background
- * Dual 120/277 voltage
- * Charge rate/power "ON" LED indicator light and push-to-test switch for mandated code compliance testing
- * 4.8V long life, maintenance-free, rechargeable NiCd battery
- * Internal solid-state transfer switch automatically connects the internal battery to LED board for minimum 90-minute emergency illumination
- * Five year warranty. Battery prorated to five year

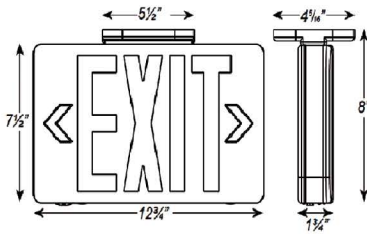

EXTSGN-WTL Wet Location Exit Sign

- * Ultra bright, energy efficient, long life Red LED's
- * Dual 120/277 voltage
- * Bi-color LED indicator light alerts occupant on battery condition (Green-normal, Red-check battery)
- * Charge rate/power "ON" LED indicator light and push-to-test switch for mandated code compliance testing
- * 4.8V long life, maintenance-free, rechargeable NiCd battery
- * Internal solid-state transfer switch automatically connects the internal battery to LED board for minimum 90-minute emergency illumination
- * Wet Location IP 65

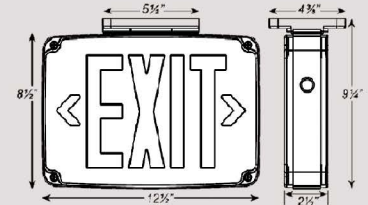

PART #	No of faces	Letter Color	Color	Battery	Feature
EXTSGN-RED	2	Universal Single/	Red	White	EM Backup
EXTSGN-BLK	2	Universal Single/	Red	Black	EM Backup
EXTSGN-RED-RC	2	Universal Single/	Red	White	EM Backup Remote capable
EXTSGN-WTL	1	Single face	Red	Grey	EM Backup



Edgelit Aluminum Exit Sign

- * Ultra bright, energy efficient, long life Red or Green LEDs
- * UV-stabilized ultra-clear acrylic edgelit panel provides consistent, uniform illumination
- * Double face utilizes factory installed silver mylar background panel
- * Dual 120/277 voltage
- * Charge rate/power "ON" LED indicator light and push-to-test switch for mandated code compliance testing
- * 4.8V long life, maintenance-free, rechargeable NiCd battery
- * Internal solid-state transfer switch automatically connects the internal battery to LED board for minimum 90-minute emergency illumination

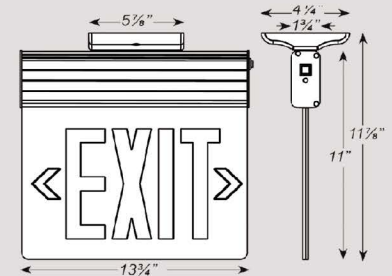

PART #	No. of faces	Letter Color	Panel	Housing Color	Battery Standard
ELEXT	1	Single face	R Red	C Clear	A Aluminum EM Battery
ELEXT	2	Double face	G Green	M Mylar	Backup

EMERGENCY EXIT COMBO



EXTCMB Exit Combo

- * Long lasting, efficient ultra bright 2 x 2.2W per head
- * High performance chrome-plated metallized reflector and plastic lens for optimal light distribution
- * Adjustable LED lamp heads provides optimal center-to-center spacing
- * Long life, energy efficient Red LED EXIT sign illumination
- * Dual 120/277 voltage standard
- * Charge rate/power "ON" LED indicator light and push-to-test switch for mandated code compliance testing
- * 9.6V long life, maintenance-free, rechargeable NiCd battery
- * Minimum 90-minute emergency illumination
- * Five year warranty. Battery prorated to five year

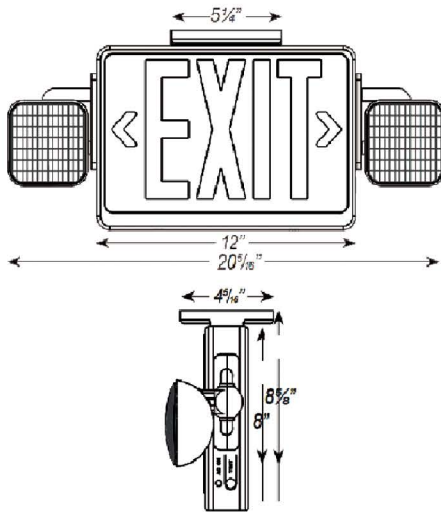

EXTCMB-VE Exit Combo Valued Engineered

- * Adjustable long lasting, efficient ultra bright white LED lamp heads
- * 2 x 2.4 watt white LED per lamp head
- * Unique all inclusive lamp, reflector and lens assembly
- * Long-lasting, energy efficient Red LED EXIT sign illumination
- * Dual 120/277 voltage standard
- * Bi-color LED indicator light alerts occupant on battery condition (Green-normal, Red-check battery)
- * Internal solid-state transfer switch automatically connects the internal battery to LED board for minimum 90-minute emergency illumination
- * Five year warranty. Battery prorated to five year
- * 3.6 NI-Cad Battery

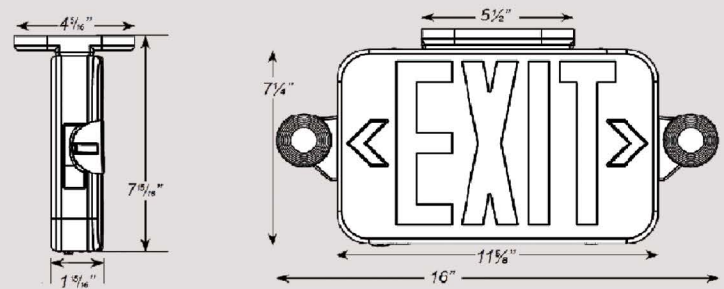

PART #	No of faces	Letter Color	Housing Color	Remote control
EXTCMB-VE	blank= Single	R Red	W White	
EXTCMB-VE-RC	blank= Single	R Red	W White	RC: Up to 3W

PART #	No of faces	Letter Color	Housing Color	Remote capable
EXTCMB-RED	1 Universal Single	R Red	W White	
EXTCMB-GRN	1 Universal Single	G Green	W White	
EXTCMB-RED/BLK	1 Universal Single	R Red	B Black	
EXTCMB-RED-RC	1 Universal Single	R Red	W White	RC: Up to 3W

EMERGENCY EGRESS



LED Emergency Light HPEM

- * High performance chrome plated metallized reflector and plastic lens
- * 1,162 lumens (581 per head x 2) @ 24 watts
- * Universal 120/277 voltage standard
- * 9.6V long life, maintenance-free, rechargeable lithium iron phosphate battery
- * Remote capacity of 3.0 watts standard
- * 90-minute emergency illumination
- * Fully automatic solid-state, two rate charger fully recharges a discharged battery in 24 hours
- * Unique bi-color LED indicator light alerts occupant on battery condition (Green-normal, Red-check battery)
- * Charge rate/power "ON" LED indicator light and push-to-test switch for mandated code compliance testing
- * Five year warranty on all electronics and housing.

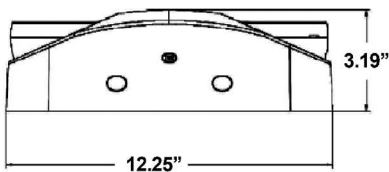
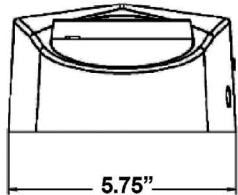

PART #	Housing Color	Wattage	Lumens
HPEM	White	12W per head	1162



LED Emergency Light EMER-BUGLT

- * Long lasting, efficient ultra bright white LED lamp heads.
- * 24 SMD
- * Adjustable LED lamp heads provides optimal lighting
- * Dual 120/277 voltage standard
- * Charge rate/power "ON" LED indicator light and push-to-test switch for mandated code compliance testing
- * 6V / 700 mAH long life, maintenance-free, rechargeable NiCd battery
- * Fully automatic solid-state, two rate charger fully recharges a discharged battery in 24 hours
- * Five year warranty on all electronics and housing.

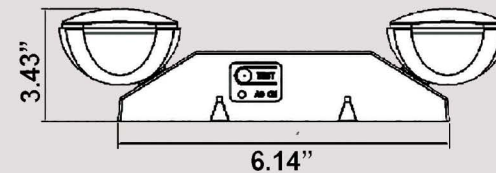
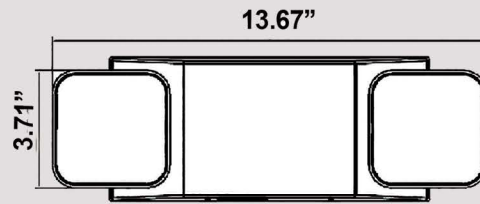

PART #	Housing Color	
EMER- BUGLT	W	White
	B	Black



LED Emergency Light Value Engineering EMER-BUGLT-VE

- * 12 SMD 2835 LED per lamp head
- * Adjustable long lasting, efficient, ultra bright white LED lamp head
- * Dual 120/277 voltage standard
- * 3.6V 700 mAH long life, maintenance-free, rechargeable Ni-Cd battery
- * Internal solid-state transfer switch automatically connects the internal battery to LED lamp heads for minimum
- * 90-minute emergency illumination
- * Fully automatic solid-state, two rate charger initiates battery charging to recharge a discharged battery in 24 hrs
- * Five year warranty on all electronics and housing.

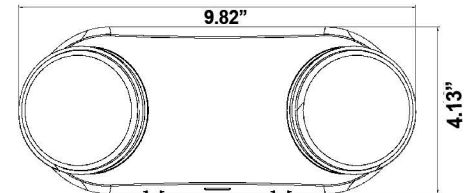
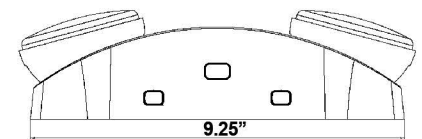

PART #	Housing Color
EMER- BUGLT-VE	White

WET RATED / OUTDOOR EMERGENCY EGRESS



MWPO6 Architectural Outdoor Die-Cast Emergency Light

- * Can be used as a Normally ON or Normaly Off fixture as well as on a switched emergency circuit
- * Offers long lasting, efficient, ultra bright white LED's.
- * 15 watt LED - 5000K -1801 Lumens @ 129 Lu/W
- * Mirror-bright reflector and prismatic polycarbonate refractor
- * Photocell control sensor included as standard for use as dusk-to-dawn fixture
- * Phillips Lumiled SMD2835 - Universal Dual 120/277 voltage
- * Charge rate/power "ON" LED indicator light and push-to-test switch for mandated code compliance testing.
- * Maintenance free, rechargeable NiCd battery
- * Internal solid-state transfer switch automatically connects the internal battery to LED board for minimum 5W 90-minute emergency illumination
- * Fully automatic solid-state, two rate charger initiates battery charging to recharge a discharged battery in 24 hrs
- * Five year warranty. Battery prorated for five year

PART #	Lu/W	Power	Lumens	Emergency
MWPO6-15W-5K	129	15W	1801	5W for 90 min



RHLED LED Polycarbonate Remote Head



- * Long lasting, efficient, ultra bright white LED lamp heads
- * 1.0 watt per head
- * 3.6V - 9.6VDC input range
- * Adjustable lamp heads provide optimal center-to-center spacing.
- * Powered from low voltage power source with low voltage wiring (not provided).
- * Universal mounting adapter plate included. Mounts to single-gang switch box
- * Five year warranty

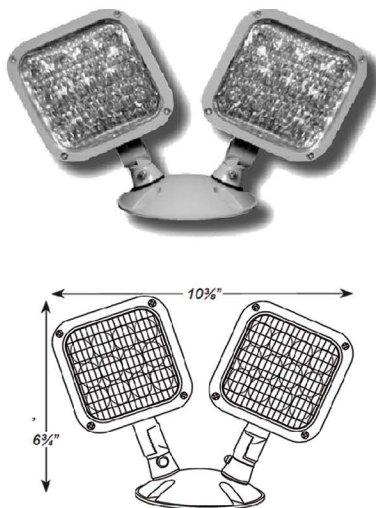

PART #	No of heads
RHLED	2 Double head



EMER-WTL Wet Location Vandal Proof Emergency Light

- * Two fully adjustable, semi-recessed ultra bright, 3.6 watt MR-16 LED lamp heads standard
- * Dual 120/277 voltage
- * Charge rate/power "ON" LED indicator light and push-to-test switch for mandated code compliance testing
- * 6V long life, maintenance-free, rechargeable sealed lead acid battery
- * Internal solid-state transfer switch automatically connects the internal battery to LED board for minimum 90-minute emergency illumination
- * Fully automatic solid-state, two rate charger initiates battery charging to recharge a discharged battery in 24 hours
- * Five year warranty on all electronics and housing. Battery prorated for two years

PART #	Housing Color	Standard Feature
EMER-WTL	Blank = Grey	Blank = wet location



WLTFX2 Wet Location Remote Capable Emergency Light



- * Sealed and gasketed weather proof lamp heads with high performance chrome-plated reflector for optimal light distribution
- * Adjustable long lasting, efficient, ultra bright white LED lamp heads
- * 1.875 watt (15 LEDs x 0.125) per head
- * Charge rate/power "ON" LED indicator light and push-to-test switch for mandated code compliance testing
- * Dual 120/277 voltage standard
- * Remote capacity of 3.7 watt standard
- * 9.6V long life, maintenance-free, rechargeable NiCd battery
- * Internal solid-state transfer switch automatically connects the internal battery to LED lamp heads for minimum 90 minute emergency illumination
- * Fully automatic solid-state, two rate charger initiates battery charging to recharge a discharged battery in 24 hours
- * Five year warranty on all electronics and housing. Battery prorated for five years



PARTS #	Housing Color
WLTFX2	Blank= Gray



EMERGENCY DRIVERS



Billda BLD-CM-20H-20W

For use with



Glass wall packs

- * External Life P04 battery
- * Battery protections: over charge protection, over discharge protection, short circuit protection
- * Indicator shows a variety working modes
- * The batteries meets 500 Cycles of standard CH and standard DCH
- * Damp location rated
- * Universal 100-277V, 50-60 Hz input
- * Test Switch indicator light
- * Output power: 20W ;
- * Output voltage: 50-150 Vdc
- * 90 Minute minimum emergency operating time over full temperature range
- * 24 Hour maximum battery recharge time
- * 3 year warranty on all electronics and housing



New IP65 proprietary test switch

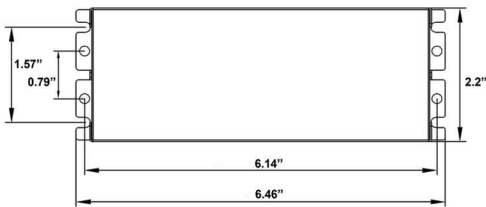

Billda BLD-HM25D

For use with



LED downlights

Linear Highbays up to 300W

- * Internal Li-ion battery
- * Self test
- * Input Voltage: 100-347V, 50-60 Hz input
- * Output power: 25W ; Output current and voltage: <100mA <170 Vdc
- * 90 Minute minimum emergency operating time over full temperature range
- * 24 Hour maximum battery recharge time. Ambient temperature: 32F to 122F
- * 3 year warranty on all electronics and housing
- * Applications: 1- <150W (0/1-10V) dimmable fixture / 2- <20W LED fixture without dimming function

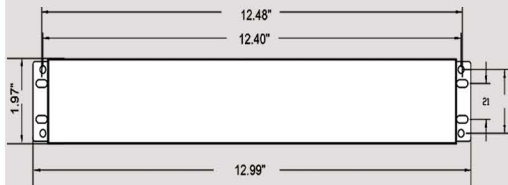

Part #	Wattage	Output voltage	Input current
BLD-HM25D	25W	< 170 VDC	< 100mA

EMUFO-40170-YY

For use with



UFO High bays

- * High output voltage 170VDC
- * CEC Title 20 compliant
- * Self-testing
- * Battery:thermal protection
- * Input Voltage:100~347Vac, 50/60Hz
- * Recharge Time: 24Hrs
- * Emergency Power: 40W
- * Discharge Time:90 min
- * 4.8V Ni-Cad battery
- * Weight:7.3 lbs(3.3kg)
- * 5-year Limited Warranty

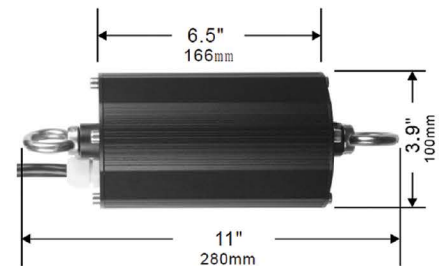

PART #	OUTPUT VOLTAGE	OUTPUT POWER
EMUFO-40170-YY	170VDC	40W

PART #	OUTPUT VOLTAGE	OUTPUT POWER	OUTPUT CURRENT
BLD-CM20H-20W	50-150	20W	250mA

EMERGENCY DRIVERS

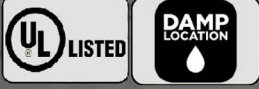

EMS8W27

For use with: 4Ft = 8W



Linear Strips lights

wrap lights

vapor tight lights

- * External Life P04 battery - 7.2 V / 2500mAh
- * Battery protections: over charge protection, over discharge protection, short circuit protection
- * The batteries meets 500 Cycles of standard CH and standard DCH
- * Universal 100-347V, 50-60 Hz input
- * Test Switch indicator light
- * Output power: 8W ; Output 36-60VDC
- * 90 Minute minimum emergency operating time over full temperature range
- * 24 Hour maximum battery recharge time
- * 5 year warranty on all electronics and housing



PART #	Output Voltage	Output Power	Dimensions case	Dimensions battery
EMS8W27	25-48	8W	7.4"x 1.5"x1.1"	6.1" x 1.2"

BLD-HM08D-8W

For use with



Backlit Panels

LED Troffers

- * Emergency power: 8W
- * Intelligent emergency automatic detection function
- * For use with switched or unswitched fixtures
- * Universal 100-347V, 50-60 Hz input
- * Output power: 8W ; 170VDC
- * Battery protections: over charge protection, over discharge protection, short circuit protection
- * High temperature, maintenance free NI-Mh battery
- * 90 Minute minimum emergency operating time
- * 24 Hour maximum battery recharge time
- * 3 year warranty



PART #	Output Voltage	Output Power(W)	Output current
BLD-HM08D-8W	170VDC	8W	250 mA



Easy field install motion sensor available



The HBB is a premium round LED UFO High Bay light. Standard die cast aluminum housing and clear PC lens, the HBB provides durability and high performance. Standard with sensor receptacle built in for easy install control options, sensor sold separately. This HBB series light is the latest in high-performance LED round high-bay technology. Engineered to replace traditional fluorescent or metal halide high-bays, the HBB delivers superior performance in a compact, easy-to-manage package. It is available in 150W, 200W and 240W in 5000K and in 150W, 200W and 300W wattage selectable and 3.5K, 4K and 5K kelvin selectable.

- * 110 to 132 Lumens per watt
- * CCT color temperature selectable: 3.5K, 4K, 5K on the CCT model. 5000K on the other models
- * Adjustable power: 200W, 240W and 300W on the CCT model. 150W, 200W or 240W available on the other models
- * LED chips 2835 with premium Sosen driver
- * Long-life LEDs provide 50,000 hours of operation with at least 70% of initial lumen output (L70)
- * Universal 100-277 AC voltage (50-60Hz) is standard
- * 0-10 V dimming capability is standard
- * Power factor > 0.90 and CRI > 80
- * Viewing angle: 90
- * Easy installation in new construction or retrofit
- * Die cast aluminum housing, painted black
- * Temperatures from -4°F to 120°F

Options (order separately)

- * Emergency driver 40W-170V: EMUFO-40170-YY
- * Motion sensor: ANT-5-4T

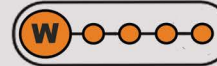

Field Selectable wattage dip switch: 200W, 240W, 300W for the CCT model

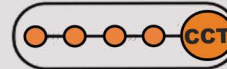

Field Selectable CCT dip switch: 3.5K, 4K and 5K for the CCT model

- * DLC Premium listed
- * FCC Part 15, class B
- * IP 65 wet location rated
- * UL Listed



All 5K models

11" 150W 5K
12.5" 200 & 240W 5K

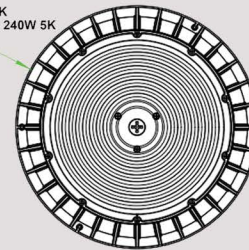

4.7" all 5K models

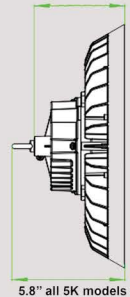

5.8" all 5K models

CCT model

13.3"

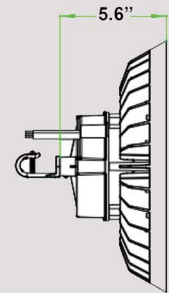
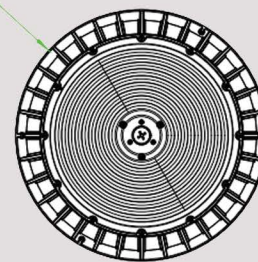

5.6"

PART #	HBB-22L-27-5K	HBB-30L-27-5K	HBB-36L-27-5K	HBB-45LS-27-CCT
Watt	150	200	240	200/240/300
Lumens/watt	151	154	152	140-163
Color Temp	5,000	5,000	5,000	3.5K, 4K, 5K CCT
Lumens	21,789	31,035	34,412	28,000 – 46,000
Voltage	100-277 VAC 50-60HZ	100-277 VAC 50-60HZ	100-277 VAC 50-60HZ	100-277 VAC 50-60HZ

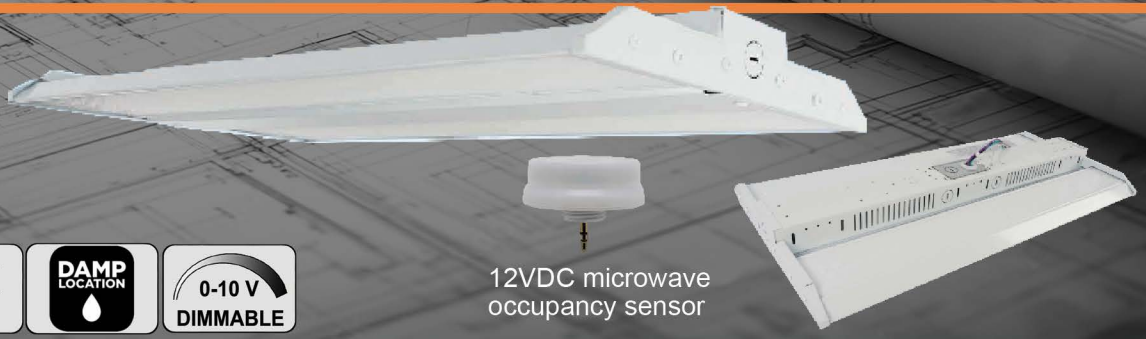

12VDC microwave occupancy sensor

This LED Linear High Bay fixture has premium quality performance and technology. Ideal for one-to-one replacements for conventional HID, T8 or T5 fixtures. The revolutionary high efficacy light output of 150 Lumens per watt will reduce overall operation costs. Primarily used as high bay lighting for commercial and industrial buildings. Standard V-hook chain mount. Pendant mount optional. Microwave motion occupancy sensor optional.

* Wattage selectable 80W, 95W, 110W and 120W, 165W, 225W (2FT model) and 165W, 225W, 300W and 270W, 340W, 400W (4FT model)

- * Kelvin selectable 4K and 5K on all models
- * Both sizes available with a built-in emergency driver (EM)
- * Mounting hardware includes V-hooks and chains
- * LED efficacy up to 150 lumens per watt
- * Universal 100-277V AC (50-60 Hz) input standard with premium Sosen driver
- * Long-life LEDs with 75,000 hours of operation
- * Equipped with 0-10V dimming capability
- * Suitable for damp location
- * Color rendering Index >80. Power factor: >0.9
- * Beam Angle : 90 Degree
- * Can operate in temperatures -4°F to 104°F
- * Manufactured for durability using a die-formed steel housing finished with polyester powder coating to resist corrosion and scratching and polycarbonate diffuser.

Factory Installed Emergency Drivers:

- * Billda HM25D

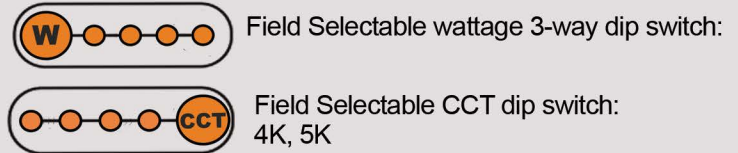

- * ETL Listed
- * DLC Premium listed
- * FCC Part 15, class B
- * Damp location

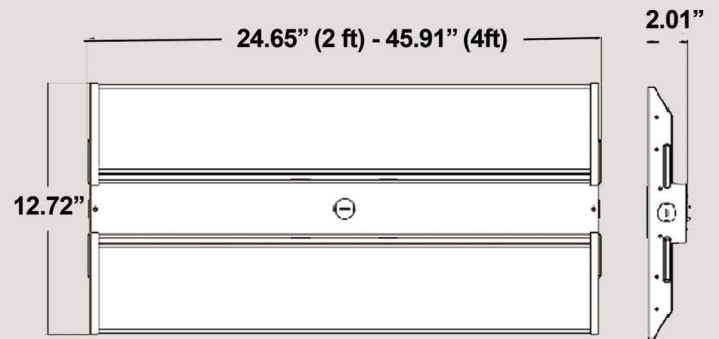

Standard Accessories

- * V hook & chain

Optional Accessories (order separately)

- * Center Pendant Mount Kit : LBH5-PENDANT
- * Occupancy Sensor ANT-5-4T or ANT-6-4T
- * 10ft Aircraft Cable Suspension Kit "Y" with hook: ACHG-10FT-KIT

PART #	Size	Wattage Selectable	Total Lumens	Kelvin Selectable	Voltage
LHB08-2FT110S-27-TCP	2 ft	80 / 95 / 110W	12,640 / 14,630 / 16,500	4K, 5K	100-277V
LHB5-2FT225S-H2-TCP	2 ft	120 / 165 / 225W	18,960 / 25,410 / 33,750	4K, 5K	100-277V
LHB5-2FT225S-H2-TCP-EM	2 ft	120 / 165 / 225W	18,960 / 25,410 / 33,750	4K, 5K	100-277V
LHB08-4FT300S-27-TCP	4 ft	165 / 225 / 300W	26,895 / 35,325 / 45,000	4K, 5K	100-277V
LHB5-4FT300S-H2-TCP-EM	4 ft	165 / 225 / 300W	26,895 / 35,325 / 45,000	4K, 5K	100-277V
LHB08-4FT400S-27-TCP	4 ft	270 / 340 / 400W	42,660 / 52,360 / 60,000	4K, 5K	100-277V

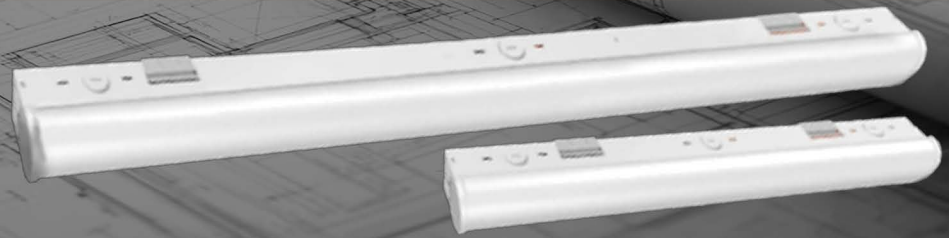

This LED strip light offers a compact low-profile style. The round frosted lens allows light to emit evenly, eliminating glare and dark ceilings. Aluminum and polycarbonate construction ensures a durable yet lightweight frame. Dimming capabilities and multiple mounting options provide adaptability to any residential or commercial space.

This light is CCT selectable 3.5K, 4K and 5K. It is also wattage selectable 15W, 20W, 25W (2FT model), 30W, 40W, 50W (4 FT model) and 50W, 64W, 80W (8 FT model). It comes with a five year warranty. This LSTRIP light features seamless light distribution with prismatic acrylic lens. It is a time-saving and cost-effective alternative to full fixture replacement.

- * Color temperature : 3.5K, 4K, 5K selectable
- * Wattage selectable: 15W, 20W, 25W (2Ft) 30W, 40W, 50W (4Ft) and 50W, 64W, 80W (8Ft)
- * 130 to 145 lumens per watt
- * Long-life LEDs provide 50,000 hours of operation
- * Universal 100-277 AC voltage (50-60Hz) is standard
- * 0-10 V dimming capability is standard
- * Power factor > 0.90 - CRI > 80 - Viewing angle: 120
- * Housing color: white
- * Strengthened ultra lightweight metal housing
- * Frosted striped diffuser



- * ETL Listed
- * DLC Premium Listed
- * Damp location rated
- * Operating temperatures from -20°F to 122°F
- * 5-yr warranty

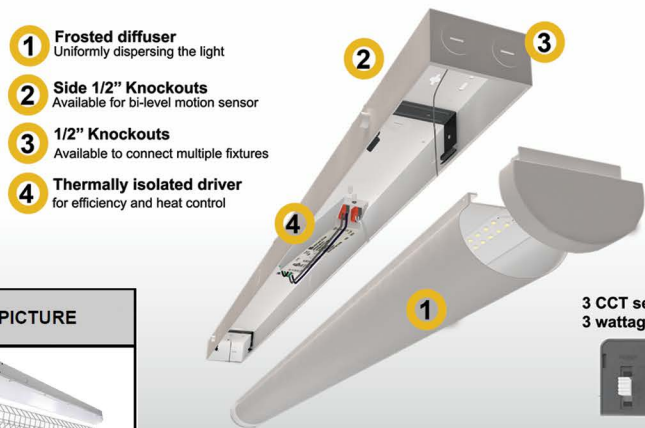
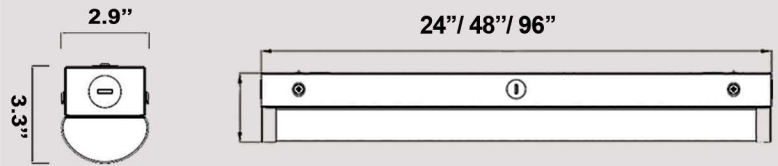

3 CCT selectable
3 wattage selectable

CATEGORY	PART #	DESCRIPTION	NOTE	PICTURE
Wire Guard	LSTRIP4FT-WIREGUARD	4' wire guard for 4ft and 8ft linear strips (order 2 sets for one 8ft linear strip). Hardware included	Order separately	
Hanging Kit	LSTRIP-HANGKIT	2 Pack Hanging kit for 2', 4' and 8' linear strip 3ft long jack chain with Y	Order separately	

PART #	Length	CCT Color Temp	Lumens	Lumen/ watt	Wattage	Voltage
LSTRIP2-3LS-27-3CCT	2 FT	3.5K, 4K, 5K	2,100 – 3,500	130 – 145	15W, 20W, 25W	100-277V
LSTRIP4-6LS-27-3CCT	4FT	3.5K, 4K, 5K	3,900 – 7,000	130 – 145	30W, 40W, 50W	100-277V
LSTRIP8-10LS-27-3CCT	8FT	3.5K, 4K, 5K	7,000 – 11,200	130 – 145	50W, 64W, 80W	100-277V

ROPE LIGHT



The 5050RL series is a flexible LED rope light that is the perfect solution for a wide variety of architectural and accent lighting applications including cove lighting, under-cabinet lighting, back-lighting, pathway lighting and decorative lighting. We offer 3 sku's in 3K white, 5K white and RGB. This rope light has an IP68 rating and can be installed indoor and outdoor.

- * LED size: 5050
- * Power: 2.4W / Ft
- * Length per unit cutting point: 19"
- * High luminous efficiency >70 LM / W Avg, energy saving more than 80%
- * Green environmental protection: no ultraviolet and infrared radiation, comply with RoHS requirements
- * No stroboscopic: fast starting , flicker-free, protects your eyes
- * Installation (embedded) is simple, flexible to meet different needs
- * Working hours: 50,000 hours
- * Input voltage: 120V

Options (oder separately)

- * Additional clips for install: ROPELIGHT-CLIPS
- * Additional power lead: ROPELIGHT-PWR-SINGLE
- * Additional controller + power lead for RGB: ROPELIGHT-PWR-RGB

- * Power Consumption: 8 watts per meter (3.3ft)
- * Illumination Angle 120°
- * IP68
- * UL Listed
- * 3-year warranty
- * Lead free technology (ROHS)
- * Working temperature -13F to 113 F
- * Working Humidity: 5% -100%



PART #	Color	Lumens per foot	Lumens per watt	Power	Lumens per roll	Roll Length
ROPELIGHT-165FT-RGB	RGB	168	>70	2.4 W/ FT – 396 W per roll	27720	165 Ft
ROPELIGHT-165FT-3K	3000K	168	>70	2.4 W/ FT – 396 W per roll	27720	165 Ft
ROPELIGHT-165FT-5K	5000K	168	>70	2.4 W/ FT – 396 W per roll	27720	165 Ft

COB 320 TAPE LIGHT

COB TUNABLE TAPE LIGHT

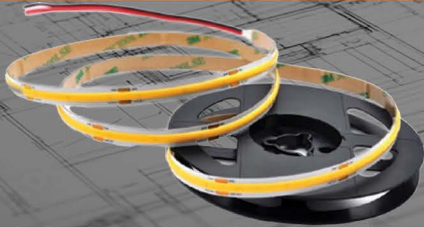

This COB tape series creates a seamless line of light. This all new strip design uses flip chip LED's to eliminate LED dots. This new chip-on-board technology improves light quality but also improves the thermal management and flexibility of the strip. These COB strips are packed smaller and weigh less than the bulkier 5050 LED's. COB 320 are available in 3K, 4K and 5K ; COB 608 are available in 2700-6500K tunable ; COB 840 are available in 2700-6500K + RGB

- * Available in 3000K, 4000K and 5000K
- * Input voltage: DC 24V
- * Power Consumption: 50W per roll -5M (3.3Ft) for IP20 / 100W per roll - 10M (6.6 Ft) for IP65
- * Illumination Angle 180°
- * IP20 and IP65 available
- * LED count: 320 per meter
- * Suggested driver: Meanwell LPV-100-24
- * Lumens : 86 lm/W - 860 lumens per meter
- * Rolls are 5m / 16.4ft. PCB is 5mm width
- * Minimum cut length: 50mm (1.97")
- * Best Color Consistency (SDCM<3)
- * Color temperature with 80 >CRI
- * Double circuit board for better electric stability

- * UL Listed
- * 3-year warranty
- * Lead free technology (ROHS)



Connectors - Purchase separately

IP20COB-320-CW	IP20COB 320 8MM PIGTAIL
IP20COB-320-CWC	IP20COB 320 8MM JUMPER
IP20COB-320-LC	IP20COB 320 8MM L CONNECTOR
IP20COB-320-CC	IP20COB 320 8MM STRAIGHT CONNECTOR
IP20COB-320-CW3M	IP20COB 320 8MM 3METER PIGTAIL
IP20COB-320-CWC3M	IP20COB 320 8MM 3METER JUMPER
IP20COB-320-CW	IP20COB 320 8MM PIGTAIL
IP20COB-320-CWC	IP20COB 320 8MM JUMPER
IP20COB-320-LC	IP20COB 320 8MM L CONNECTOR
IP20COB-320-CC	IP20COB 320 8MM STRAIGHT CONNECTOR
IP20COB-320-CW3M	IP20COB 320 8MM 3METER PIGTAIL
IP20COB-320-CWC3M	IP20COB 320 8MM 3METER JUMPER

- * Available in 2700-6500K tunable and 2700-6500K + RGB
- * Input voltage: DC 24V
- * Power Consumption: 50W per roll -10W/meter (3.3Ft) (COB 608) and 100W per roll - 20W/meter (COB 840)
- * Illumination Angle 180°
- * IP20
- * LED count: 608 and 840 per meter
- * Suggested driver: Meanwell LPV-100-24
- * Rolls are 5m / 16.4ft.
- * PCB is 10mm width (COB 608) and 12mm (COB 840)
- * Minimum cut length: 50mm (1.97")
- * Best Color Consistency (SDCM<3)
- * Color temperature with 80 >CRI
- * Double circuit board for better electric stability
- * Soldering free connector for convenient installation channel controller

- * UL Listed
- * 3-year warranty
- * Lead free technology



Connectors - Purchase separately

- * COB-10MM-SEC: 10mm single ended connector for COB608 white tunable light
- * COB-10MM-DEC: 10mm double ended connector for COB608 white tunable light
- * COB-12MM-SEC: 12mm single ended connector for COB840 RGB+CCT light
- * COB-10MM-DEC: 12mm double ended connector for COB840 RGB+CCT light

Controler - Purchase separately

- * CLL-RC-T-CCT: White tunnable color temperature controller for COB 608
- * CLL-RON2-043A: RGB + white tunnable controller for COB 840



PART #	Rating	Voltage	Lumens per watt	Power	Lumens per roll	Color temp
IP20COB-320-24-5M-3K	IP20	24	86	10W/ M / 3.3 Ft	4,300	3000K
IP20COB-320-24-5M-4K	IP20	24	86	10W/ M / 3.3 Ft	4,300	4000K
IP20COB-320-24-5M-5K	IP20	24	86	10W/ M / 3.3 Ft	4,300	5000K
IP65COB-320-24-10M-3K	IP65	24	86	10W/ M / 3.3 Ft	6,600	3000K
IP65COB-320-24-10M-4K	IP65	24	86	10W/ M / 3.3 Ft	6,600	4000K
IP65COB-320-24-10M-5K	IP65	24	86	10W/ M / 3.3 Ft	6,600	5000K

PART #	Voltage	Tape width	Power	Color temp
COB608IP20-24V-5M-tunable	24	10mm	10W per meter / 3.3 Ft	2700-6500K
COB840IP20-24V-5M-RGB-CCT	24	12mm	20W per meter / 3.3 Ft	RGB-2700-6500K

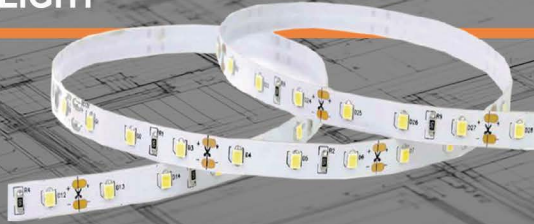

Class 2
Class P



Our 2835FX60 series flexible LED strip lights are made with a factory soldered lead on one end of a 16.4' reel, allowing you to cut every 4 inches to the exact length that you need. We offer 8mm, 16.4 ft rolls, available in IP20.

- * LED count: 60 per meter (18 per foot)
- * Suggested driver: DR-CV-40
- * Color: Available in 3000K, 4000K and 5000K
- * Reels are 5m / 16.4' 8mm (IP20)
- * Input voltage: DC 24V
- * Power Consumption: 8 watts per meter (2.4W per ft)
- * Illumination Angle 120°
- * Working hour 50,000 hours
- * SMD LED spacing: .65"- 16.6 mm
- * PCB Width 8mm
- * Color temperature with 80 >CRI
- * Double circuit board for better electric stability
- * Soldered free connector for convenient installation
- * Input voltage: DC 24V
- * Tested in accordance with IESNA LM 80
- * UL Listed
- * 3-year warranty
- * Lead free technology (ROHS)



- * Constant Voltage Driver
- * Universal Input: 100-277VAC
- * Built-in active PFC
- * Power Factor: up to 0.98
- * Efficiency: up to 83% - THD at full load is < 20%
- * Load: 10-100%
- * Protection: short circuit/over load/over heat
- * Flicker-free
- * Dimming options: Triac/Phase, 0-10V Potentiometer, 10V PWM
- * 0-100% dimmable with dimmer
- * Safety standard: UL8750+UL1310
- * Working temp: -40F to 140 F
- * Over temperature : 212 F +/- 10% shut down O/P voltage, automatic recovery after cooling
- * Working humidity: 20-90% non condensing
- * UL Listed
- * Complies with FCC
- * Damp location

PART #	Voltage	Power In Watt	Voltage Range	Dimming 0-10V	TRIAC / PHASE	10V PWM
VPA096-24	24	96	100-277 VAC	YES	YES	YES
VPA192-24	24	192	100-277 VAC	YES	YES	YES
VPA288-24	24	288	100-277 VAC	YES	YES	YES

PART #	LED	Lumens per watt	POWER	Lumens per roll	Roll Length
2835FX60-3K-IP20-5M	3000K	100	2.44W/ FT – 40 W per roll	4000	16.4Ft
2835FX60-4K-IP20-5M	4000K	104	2.44W/ FT – 40 W per roll	4160	16.4Ft
2835FX60-5K-IP20-5M	5000K	106	2.44W/ FT – 40 W per roll	4240	16.4Ft



LED Modules are designed to be used in channel letters and signs and are an ideal replacement for neon lights and other traditional advertising lighting application. LED Modules are a great versatile product because there is 4 inch lead wire between each LED Module, making them easy to cut and re-connect for any custom project. All LED Modules are IP65 waterproof.

12V MODULES

- * Low power consumption
- * High brightness, full range colors are available
- * Long lifespan: 50,000 hours at least
- * Voltage: DC12V
- * Color: Red / Green "solid only"
- * Color: White in 3000K, 4000K and 6500K
- * Beam Angle: 160 degrees
- * Led type: SMD 2835 Led
- * QTY: 3PCS per module
- * Power: 1.5W
- * Lumen Output: 240 LM per ft White Module
- * 3 year warranty



PART #	Voltage	Power	Color	Lumens per feet	Size
MODULE-1.5W-RED	12V	1.5W	Red	240	3.3" x 0.75" x 0.30"
MODULE-1.5W-GREEN	12V	1.5W	Green	240	3.3" x 0.75" x 0.30"
MODULE-1.5W-3000K	12V	1.5W	White	260	3.3" x 0.75" x 0.30"
MODULE-1.5W-4000K	12V	1.5W	White	270	3.3" x 0.75" x 0.30"
MODULE-1.5W-6500K	12V	1.5W	White	280	3.3" x 0.75" x 0.30"



120V MODULES

- * 6500K color temperature
- * AC120V - no AC driver required - 3W
- * SMD2835 LED
- * 3 Pieces LED modules
- * IP67
- * UL Listed
- * Sold by the bag of 100 pieces



PART #	Voltage	Power	Color	Lumens per feet	Size
MODULE2835-3W- 110V-6500K	120V	3W	White	280	3.3" x 0.75" x 0.30"

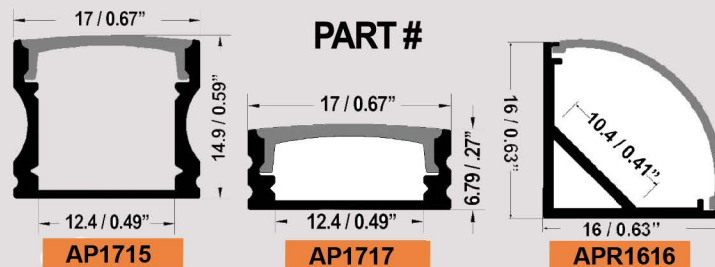

- * Installation: recessed or surface mount (clip mounted)
- * Suitable for 6-12mm tape lights
- * Length: 1 meter / 3.28 ft
- * Silver 6063 Aviation Aluminum
- * Frosted PC cover
- * Cable output: from bottom or end
- * PC transmittance: 85%
- * Includes clips and end caps

Model-No	AP1707	AP1715	AP1616
Surface technology	Anodic oxidation	Anodic oxidation	Anodic oxidation
Installation method	Clip/Mount	Clip/Mount	Clip/Mount
Aluminium Color	Silver	Silver	Silver
Material	6060 Aviation Aluminum	6060 Aviation Aluminum	6060 Aviation Aluminum
Product Size	17" 07*11000 mm	17*14.5*11000 mm	16*16*11000 mm
PC Cover	White / Milky	White / Milky	White / Milky
PC Transmittance	85%	85%	85%
Application cond.	Indoor	Indoor	Indoor

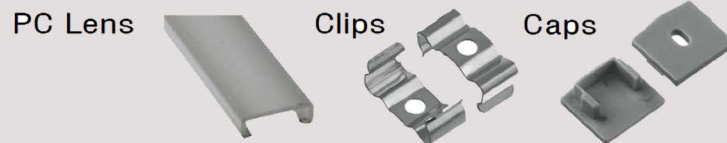

12/24 DRIVERS



PWM-60-12
PWM-120-12



LPV-60-12



PART #	PWM-120-12	PWM-60-12	LPV-60-12
DC Voltage	12V	12V	12V
Rated Current	10A	5A	5A
Rated Power	120W	60W	60W
Water Protection	IP 67 – WET	IP 67 - WET	IP 54 – DAMP
Dimming capability	YES	YES	NO
Dimming capability	0-10V	0-10V	N/A
Voltage Range	90-305 VAC	90-305 VAC	90-305 VAC
AC Current (Type) 115V	1.3 A	0.8 A	1.2 A
AC Current (Type) 230V	0.65 A	0.4 A	1 A
AC Current (Type) 277V	0.55 A	0.32 A	N/A
Dimension	7.5" x 2.5" x 1.5"	5.9" x 2.1" x 1.38"	6.4" x 1.7" x 1.25"
Warranty	5 years	5 years	2 years



PWM-60-24
PWM-120-24



LPV-100-24
LPV-60-24



DR-CV-80
DR-CV-40

PART #	PWM-120-24	PWM-60-24	LPV-60-24	LPV-100-24	DR-CV-80	DR-CV-40
DC Voltage	24V	24V	24V	24V	24V	24V
Rated Current	5A	2.5A	2.5A	4.2A	3.3A	1.6A
Rated Power	120W	60W	60W	100W	80W	40W
Water Protection	IP 67 – WET	IP 67 – WET	IP 54 – DAMP	IP 54 – DAMP	IP 20 -DRY	IP 20 DRY
Dimming capability	YES	YES	NO	NO	YES	YES
Dimming capability	0-10V	0-10V	N/A	N/A	Triac	Triac
Voltage Range	90-305 VAC	90-305 VAC	90-264 VAC	90-264 VAC	90-130VAC	90-130VAC
AC Current (Type) 115V	1.3 A	0.8 A	1.2 A	2.2 A	1.1 A	0.47 A
AC Current (Type) 230V	0.65 A	0.4 A	1 A	1.2 A	N/A	N/A
AC Current (Type) 277V	0.55 A	0.32 A	N/A	N/A	N/A	N/A
Dimension	7.5" x 2.5" x 1.5"	5.9" x 2.1" x 1.38"	6.4" x 1.7" x 1.25"	7.5" x 2.04" x 1.45"	6.7" x 2.1" x 1.22"	4.25" x 1.7" x 0.95"
Warranty	5 years	5 years	2 years	2 years	3 years	3 years

TUBE READY FIXTURE



Clear



These LED T8 lamps replace conventional fluorescent lamps in existing fixtures and are all dual-ended ballast bypass, which means they are hot on both ends. They offer significant energy-efficiency and lifetime improvements over fluorescent lamps, and require bypassing the existing fluorescent ballasts, and hard-wiring tombstone lamp-holders directly to incoming AC power leads. Dual-ended bypass lamps eliminate the need to replace shunted tombstone lamp holders in existing fluorescent fixtures.

- * Color temperature : 5000K, and 5700K available depending on model.
- * Available only in clear
- * Long-life LEDs provide 50,000 hours of operation
- * Aluminum housing for improved heat dissipation
- * Universal 120-277 AC voltage (50-60Hz) is standard
- * Suitable for dry location only
- * Power factor > 0.90
- * Beam Angle: 120 degrees
- * Color rendering index > 80
- * Easy installation in new construction or retrofit
- * Working temperature: -4 F +122 F
- * Ballast Bypass double ended wiring
- * ETL Listed
- * DLC Listed
- * Complies with FCC Part 15, Class A
- * Complies with RoHS (Restriction on Hazardous Substances) requirements
- * 5-year warranty on all electronics and housing



Tube Ready Fixture are designed for maximum flexibility, pre-wired for Single/double ended line voltage LED tubes (Type B) and external driver double ended LED tubes (Type C). These fixtures, coupled with our LED retrofit tubes, provide the end-user with the ability to address their specific needs with maximum ROI: low costs, ease of maintenance, energy savings, and low installation times.

- * Pre-wired for bypass / Input Single/double-ended LED T8 tubes
- * 100-277V Standard
- * Post painted white steel body
- * Compatible with any suitable T8 LED tubes
- * Galvanized sheet steel body
- * ETL Listed
- * Rated for dry and damp locations construction
- * 5-year limited warranty

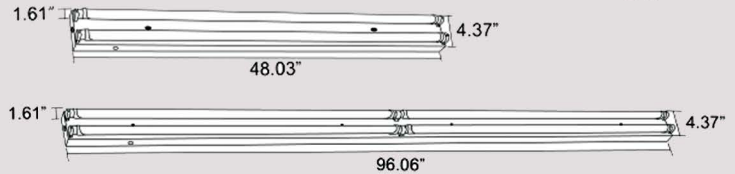

8Ft TRF comes with everything needed to do a 2 piece 8Ft or 4 pieces 4Ft

PART #	Length	# of tubes	Voltage
TRF4FT2L4 -G3	4Ft	2 x 4Ft	AC 100-277V
TRF8FT2L8 -G3	8Ft	4 x 4Ft / 4 x 8Ft	AC 100-277V

PART #	Color Temp	Lumens	Lens	Lumen/watt	Wattage	Pin/ base option	Length	Voltage
T8LO-4FTB-18-5K-C	5000K	1,980	Clear	110	18	Double pin	4ft	AC 100-277V
T8LO-4FTB-18H-5.7K-C	5700K	2,340	Clear	130	18	Double pin	4ft	AC 100-277V
T8LO-8FTB-40(FA8)-5K-C	5000K	4,400	Clear	110	40	Single pin	8ft	AC 100-277V
T8LO-8FTB-40(FA8)-5.7K-C	5700K	6,000	Clear	150	40	Single pin	8ft	AC 100-277V



FROSTED FINISH

This tube light series of LED T8 lamps replace conventional fluorescent lamps in existing fixtures and are all dual-ended bypass, which means they are hot on both ends. They offer significant energy-efficiency and lifetime improvements over fluorescent lamps, and require bypassing the existing fluorescent ballasts, and hard-wiring tombstone lamp-holders directly to incoming AC power leads. Dual-ended bypass lamps eliminate the need to replace shunted tombstone lamp holders in existing fluorescent fixtures.

These tubes features 4ft and 8ft, 5-field CCT selectable options, allowing users to customize the lighting environment to their preference. Additionally, it offers a 5-wattage selectable feature, providing flexibility in adjusting the brightness level. These options enable users to tailor lighting conditions to suit different settings and requirements, ensuring optimal ambiance and energy efficiency.

With a rated life of 50,000 hours, these tubes are built to last by making it a reliable and cost-effective solution for a wide range of applications. It carries a 5 year warranty.

- * CCT: color temperature selectable 3.5K, 4K and 5K, 5.7K and 6.5K
- * Adjustable power: 10W, 12W, 15W, 18W, 24W for the 4 ft models 24W, 30W, 36W, 42W, 48W for the 8ft models
- * 150 to 163 lumens per watt
- * Plastic / Aluminum | 4' and 8' LED T8 Tubes | G-13 Base + R17D 8 Ft option
- * Power factor > 0.95 - CRI > 80 - THD < 20%
- * Viewing angle: 120°
- * 150 to 163 lumens per watt
- * Long-life LEDs provide 50,000 hours of operation
- * Bypass ballast runs on 120-277V line voltage preferred
- * Type A+B (Double Ended Wiring)
- * Compatible with most instant and programmed-start electronic T8 ballasts
- * Easy installation in new construction or retrofit
- * Frosted cover



- * DLC 5.1 premium listed
- * ETL Listed
- * Damp location
- * FCC Part 15, class A
- * Operating Temperatures -4°F to 131°F
- * 5 Year warranty

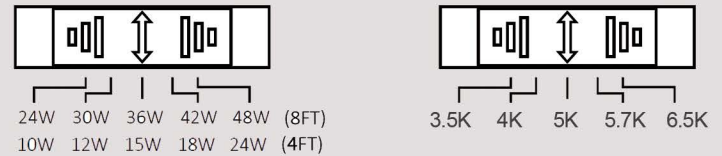

Slide dial switch to get the desired wattage & color temperature.

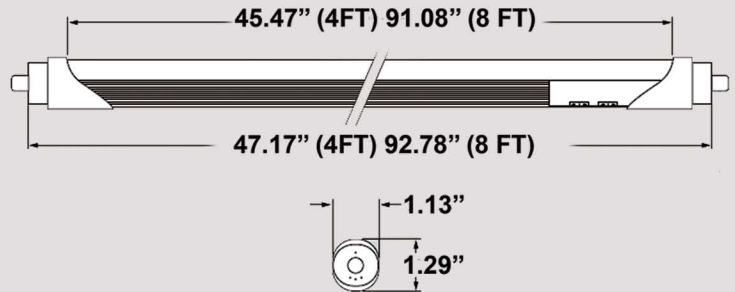

PART #	Color Temp	Lumens	Lens	Lumen/watt	Wattage	Pin/ base option	Length
T84F-M24W-CCT-AB	3.5K, 4K, 5K, 5.7K, 6.5K	1,600 -3,048	Frosted	149 – 165	10,12,15,18,24W	Double pin	4ft
T88F-M48W-CCT-AB	3.5K, 4K, 5K, 5.7K, 6.5K	3,840 – 7.344	Frosted	149 – 165	24,30,36,42,48W	Double pin	8ft
R17D-T88F-M48W-CCT-AB	3.5K, 4K, 5K, 5.7K, 6.5K	3,840 – 7.344	Frosted	149 – 165	24,30,36,42,48W	R17D"HO"	8ft



The LEDUC series is an economical line of undercabinet fixtures for use in kitchens, retail displays and coves. It is triac dimmable. Standard with a painted steel housing and polycarbonate lens, the LEDUC provides durability and high performance. High-efficacy, long-life LEDs provide both energy and maintenance cost savings compared to traditional, incandescent or fluorescent undercabinet fixtures.

- * Kelvin selectable in 3K,4K, and 5K color temperature
- * Long-life LEDs provide at least 50,000 hours of operation with at least 70% of initial lumen output (L70)
- * Delivers from 320 to 1,660 lumens & 80 to 85 lumens per watt
- * 120V (50-60Hz), triac dimmable
- * Total harmonic distortion < 20%
- * On-off switch
- * Color rendering index > 80
- * 109 degree beam angle
- * Painted steel housing and polycarbonate lens
- * Tool-less access to LED channel and wiring enclosure
- * Knockouts on sides and back simplify electrical connections
- * Key hole slots provide for easy installation in new construction or retrofits

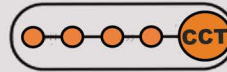

Field Selectable CCT dip switch:
3K, 4K, 5K,

- * ETL listed. Listed for damp locations. Suitable for ambient temperatures from -4°F to 104°F
- * Complies with RoHS (Restriction on Hazardous Substances) requirements
- * Complies with FCC Part 15, class B
- * 5-year warranty on all electronics and housing

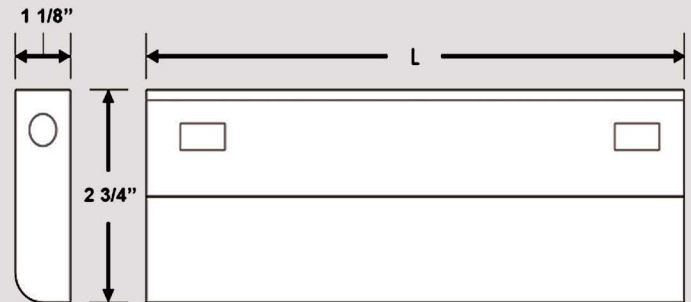

PART #	Color Temp	Lumens	Lumen/watt	Wattage	Length	Input Voltage	Triac Dimming
LEDUC-9-3CCT	3K,4K,5K	320	80	4	9"	120V	Yes
LEDUC-12-3CCT	3K,4K,5K	400	80	5	12"	120V	Yes
LEDUC-18-3CCT	3K,4K,5K	650	82	8	18"	120V	Yes
LEDUC-24-3CCT	3K,4K,5K	850	85	10	24"	120V	Yes
LEDUC-33-3CCT	3K,4K,5K	1,250	83	15	33"	120V	Yes
LEDUC-42-3CCT	3K,4K,5K	1,660	83	20	42"	120V	Yes

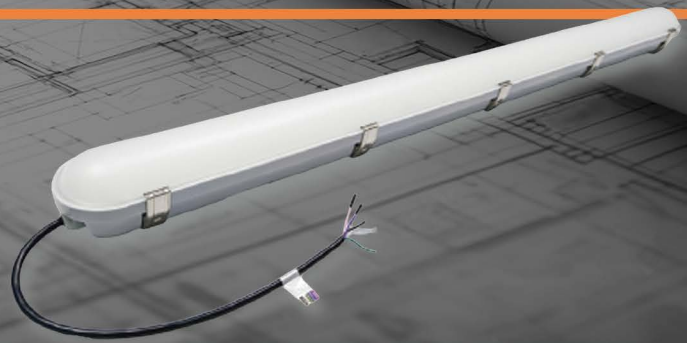

These vapor tight surface-mounted LED lights are available in 2Ft, 4Ft and 8Ft, designed to prevent the intrusion of moisture and dust. This high-efficacy light provides long-life and uniform illumination, as well as standard 0-10vdc dimming capability. Tunable 5-CCT (3500K, 4000K, 5000K, 5700K and 6500K) and Tunable 5-Wattage 2-Ft: 12W, 15W, 18W, 22W, 25W ; 4-FT: 25W, 30W, 35W, 40W, 50W or 8-FT: 50W, 60W, 70W, 80W, 100W.

Durable Construction: Built with sturdy materials like polycarbonate, and high-impact diffusers to withstand harsh conditions, impacts, and corrosion.

IP Ratings: This light carries an Ingress Protection (IP) rating of IP65, indicating resistance to dust and water jets.

This makes them suitable for use in wet locations, wash-down areas, and dusty environments

Versatile Mounting: Can be surface-mounted or suspended, offering flexibility for different installation requirements.

- * CCT: color temperature selectable 3.5K, 4K, 5K, 5.7K, 6.5K
- * Adjustable power: 12, 15, 18, 22, 25W for the 2Ft light
- * Adjustable power: 25, 30, 35, 40, 50W for the 4Ft light
- * Adjustable power: 50, 60, 70, 80, 100W for the 8Ft light
- * LED chips 2835, IP protected
- * 125 to 130 lumens per watt
- * Long-life LEDs provide 50,000 hours of operation
- * Universal 100-277 AC voltage (50-60Hz) is standard
- * 0-10 V dimming capability is standard
- * Power factor > 0.90
- * CRI > 80
- * Easy installation in new construction or retrofit
- * Integrated design comes equipped with stainless steel latches for quick access to fixture cavity
- * Battery backup option available on the 4ft model
- * Integrated quick connect to easily add motion sensor (sold separately)

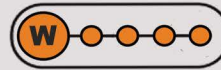

Field Selectable wattage dip switch:

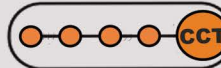

Field Selectable CCT dip switch:

- * DLC 5.1 premium listed
- * ETL listed
- * LED chips 2835, IP protected
- * IP65 wet location
- * Operating temperatures from -4°F to 120°F



Impact-Resistant Housing

- * Constructed from durable plastic resins designed to keep moisture, dust, and debris away from internal components.

Motion Sensor (Sold Separately)

- * US002-01VP Heisen quick connect microwave motion sensor

PART #	LUMENS	WATTAGE SELECTABLE	CCT TUNABLE
VP2F-M25W-CCT	1,500 – 3,250	12, 15, 18, 22, 25W	3.5K, 4K, 5K, 5.7K, 6.5K
VP4F-M50W-CCT	3,125 – 6,500	25, 30, 35, 40, 50W	3K, 3.5K, 4K, 4.5K, 5K
VP8F-M100W-CCT	6,250 – 13,000	50, 60, 70, 80, 100W	3K, 3.5K, 4K, 4.5K, 5K

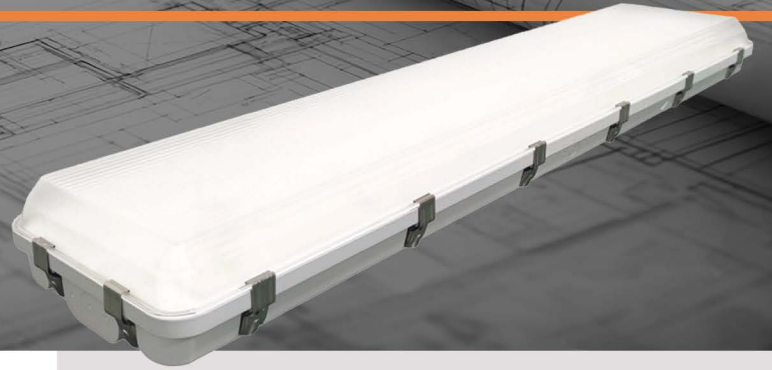

This VHB Wattage and Kelvin selectable Vapor tight light provides a gasketed dust-free and moisture free enclosure. It is a surface-mounted LED light, and provides general ambient lighting in commercial and industrial settings, and is the perfect choice for both new construction and retrofits. It is rated wet location.

This LED vapor tight is equipped with multiple wattage and CCT options thanks to a selectable switch located inside of the vapor tight light, allowing you to customize the lighting to your needs. The 0-10 Volt dimming feature allows light output to be adjusted to your needs when paired with a compatible dimmers. Plus, you receive an LED L70 lifetime of 100,000 hours, cutting down on replacement costs and hassle.

- * Driver efficacy: 88%
- * Wattage: 155W/ 185W / 200W selectable
- * 160 Lu/W
- * 24,800 lm / 29,600 lm / 32,000 lm Lumens
- * Color temperature : 3500K, 4000K, 5000K
- * Long-life LEDs provide 100,000 hours of operation
- * Universal 120-277 AC voltage (50-60Hz) is standard
- * Power factor > 0.90
- * Beam Angle: 115 degrees
- * Color rendering index > 80
- * Waterproof rating: wet location
- * 0-10V dimming capability
- * Made of high quality material, high ignition point.
- PVC lens
- * Working temperature: -40F - 104F



Field Selectable wattage dip switch:
155, 185, 200W

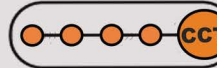

Field Selectable CCT dip switch:
3.5K, 4K, 5K,

- * UL listed
- * Wet location rated
- * Complies with FCC Part 15, class A
- * DLC Premium 5.1 Listed
- * 5-year warranty of all electronics and housing

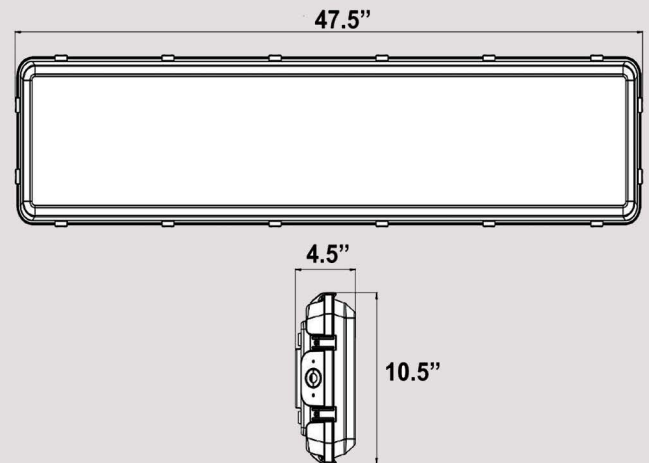

Accessory sold separately

- * V-Hook, brackets, screws, plastic tube, waterproof plug

PART #	Selectable Color Temp	Lumens	Lumen/watt	Selectable Wattage	Accessory (sold separately)
VHB-200W-27-3CCT	CCT: 3.5K, 4K,5K	24,490 to 32,400	158 to 162	155 / 185 / 200	V-Hook, brackets, screws, plastic tube, waterproof plug



This 4Ft LED wrap around fixture is the ideal multipurpose light for both front and back of the house applications. The prismatic lens prevents glare while filtering an even flow of light. Essential in restrooms, stocking areas, hallways, or anywhere a surface mounted enclosed fixture is needed. Manufactured with a slim profile design and lightweight frame for easy install. Knockouts are available in both end caps of the driver cover for surface mounting applications and accessories such as optional occupancy sensors. End-cap access design allows quick opening of the fixture for installation and maintenance. Lens can be removed without tools for simplified servicing. Fixture profile is designed to help cover existing ceiling marks or surface imperfections during replacement installations

- * Kelvin Selectable 3K, 3.5K, 4K, 5K, 6.5K
- * Wattage Selectable : 20W, 25W, 33W, 40W
- * 140 to 145 Lumens / Watt
- * 2,800 to 5,800 Lumens
- * Long-life LEDs provide at least 100,000 hours of operation with at least 70% of initial lumen output (L70)
- * Universal 120-277 AC voltage (50-60Hz) is standard
- * Total harmonic distortion < 20%
- * 0-10V dimming
- * Color rendering index > 80
- * Steel Housing
- * Frosted lens

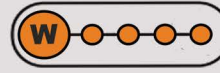

Field Selectable wattage dip switch:
20W, 25W, 33W, 40W

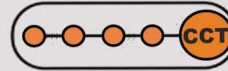

Field Selectable CCT dip switch:
3K, 3.5K, 4K, 5K, 6.5K

- * UL Listed
- * DLC Premium 5.1 Listed
- * IP65 Wet Location Rated
- * Operating Range from -4°F to 122°F
- * 5-year Warranty

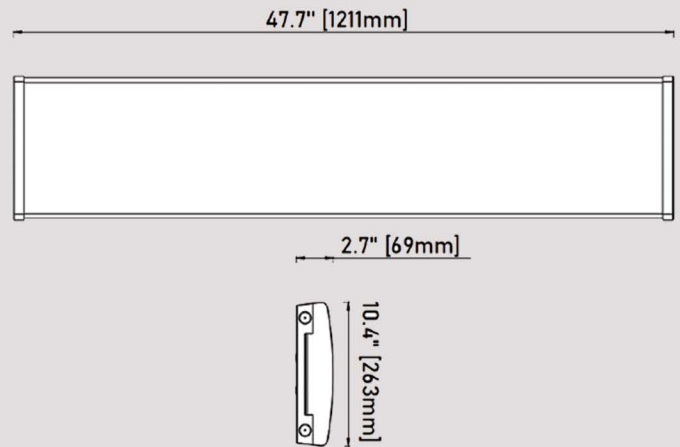

Motion Sensor (Sold Separately)

- * US002-01VP Heisen quick connect microwave motion sensor

PART #	Kelvin Selectable	Lumens	Lumens / Watt	Wattage Selectable	Length
WRP-4FT-M40W-5CCT-S	3K, 3.5K, 4K, 5K, 6.5K	2,800 to 5,800	140 LU/W to 145 Lu/W	20W / 25W / 33W / 40W	4FT



This Landscape spot light series is an ideal solution for general site, landscape, sign and pathway lighting. Manufactured for durability using a die-formed steel housing finished with polyester powder coating to resist corrosion, scratching and a tampered glass lens with seamless silicone gasket to prevent leaks. It will stand up to many years of punishing environmental conditions. Knuckle mount and photocell are standard. It is wattage selectable 15W, 20W and 25W and CCT selectable 3K, 4K and 5K. With a rated life of 50,000 hours, the BLT is built to last. Our flood lights offer adjustable beam angles with NEMA ratings of 4H4V, 5H5V, and 6H6V, allowing you to direct light precisely where it's needed for optimal coverage and safety in your outdoor spaces.



- * DLC 5.1 premium listed
- * UL listed
- * IP65 wet location
- * FCC Part 15, class B
- * Operating temperatures from -40°F to 122°F



- * CCT: color temperature selectable 3K, 4K and 5K
- * Adjustable power: 15W, 20W, 25W
- * Lumens per watt: 115 to 130 lumens
- * Long-life LEDs provide 50,000 hours of operation
- * Universal 100-277 AC voltage (50-60Hz) is standard
- * 0-10 V dimming capability is standard
- * Bronze Die cast aluminum housing
- * Power factor > 0.90 - CRI > 80
- * Beam angle: selectable 4H4V ; 5H5V ; 6H6V
- * Photocell standard
- * Knuckle mount standard

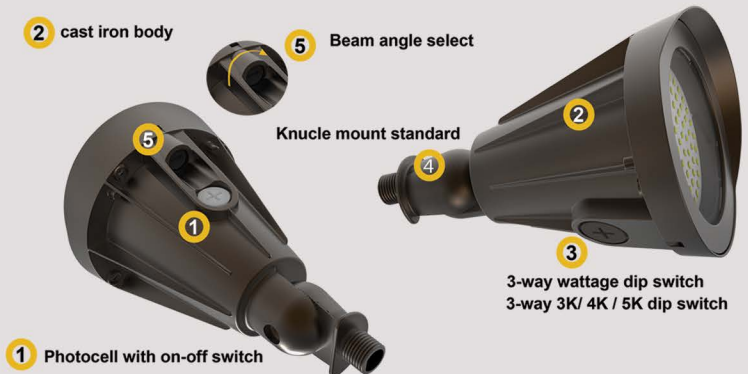
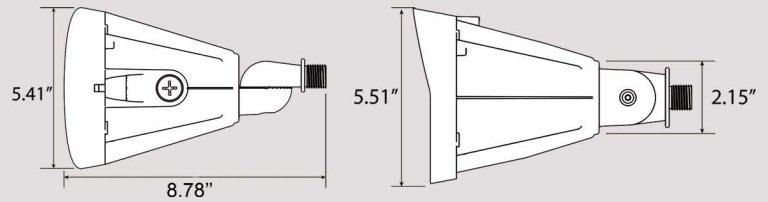

CATEGORY	PART #	DESCRIPTION	NOTE	PICTURE
Photocell	N/A	Built-in on-off photocell	Included	
Knuckle Mount	N/A	Knuckle mount	Included	
Canopy Plate	FL17-PLATES	Canopy mount plate for 1/2" NPT knuckle to flat surface or recessed box.	Order separately	
Spike Mount	LNDSL-BS	Spike mount	Order separately	
Slip-fitter adapter	TADP2.5-1/2-D	Slip-fitter adapter to 1/2" NPT knuckle mount	Order separately	

PART #	CCT Color Temp	Lumens	Lumen/ watt	Wattage	Voltage
BLT-3LS-TCP-KN-PC	3K, 4K, 5K	1,715 – 3,250	115 – 130	15W, 20W, 25W	100-277V



This MPAL 35W and 80W CCT are designed to illuminate parking areas, pathways, building facades, loading docks and a wide variety of other large general site lighting applications. This light is kelvin selectable in 3K, 4K and 5K. A knuckle mount or yoke mount are available. This light series uses dip-switches to switch between three wattage and 3 CCT ranges. This MPAL is an efficient high performing solution with a low-profile design. It is rugged on the outside with cast aluminum housing that minimizes wind load and featuring an integrated, waterproof driver compartment. It has a pre-treated and a bronze powder-coated Die-cast housing. Standard with integrated photocell.

- * CCT: 3 color temperature selectable in the field
- * Wattage: 3 adjustable power selectable in the field
- * DLC 5.1 premium listed
- * UL listed for wet location IP 65
- * Integrated photocell
- * 118 to 142 lumens per watt
- * 55/75/90 beam angle selectable
- * Universal 100-277 AC voltage (50-60Hz) is standard
- * 0-10 V dimming capability is standard

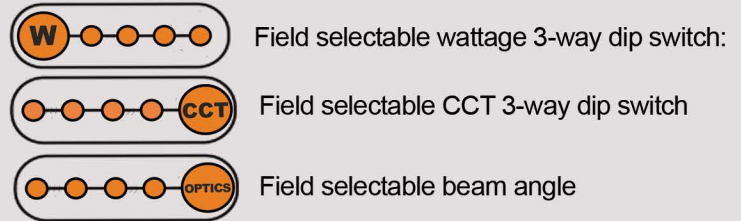

- * CCT: color temperature selectable 30K, 4K, 5K
- * Adjustable power: 15, 25, 35W on the 35S model
- * Adjustable power: 40, 60, 80W on the 80S model
- * Adjustable beam angle
- * LED chips 2835
- * IP 65 wet location rated
- * Operating temperatures from -40°F to 120°F
- * Power factor > 0.90
- * CRI > 80



CATEGORY	PART #	DESCRIPTION	NOTE	PICTURE
Photocell	N/A	Integrated photo control	Included	
Canopy Plate	FL17-PLATES	Canopy mount plate for 1/2" NPT knuckle to flat surface or recessed box. Enclosure is sealed with water tight rubber sealed gasket	Order separately	
Spike Mount	LNDSL-BS	Spike mount	Order separately	
Slip-fitter adapter	TADP2.5-1/2-D	Slip-fitter adapter to 1/2" NPT knuckle mount	Order separately	

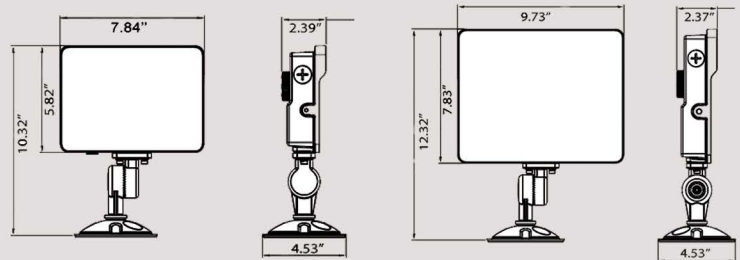

MPAL-4LS-TCP-KN-PC

MPAL-10LS-TCP-KN-PC

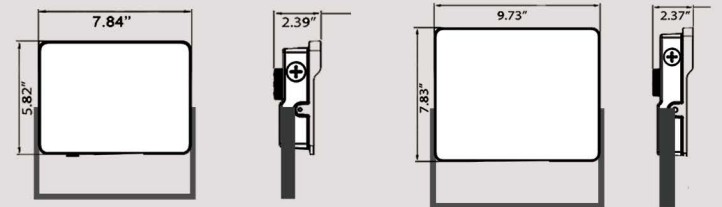

MPAL-4LS-TCP-YK-PC

MPAL-10LS-TCP-YK-PC

PART #	Mount	CCT Color Temp	Lumens	Lumen/watt	Wattage	Voltage	Beam
MPAL-4LS-27-TCP-KN-PC	Knuckle	3K, 4K, 5K	1,770 – 4,795	118 – 137	15, 25, 35W	100-277V	55 / 75 / 90
MPAL-10LS-27-TCP-KN-PC	Knuckle	3K, 4K, 5K	5,120 – 11,360	128 -142	40, 60, 80W	100-277V	55 / 75 / 90
MPAL-4LS-27-TCP-YK-PC	Yoke	3K, 4K, 5K	1,770 – 4,795	118 – 137	15, 25, 35W	100-277V	55 / 75 / 90
MPAL-10LS-27-TCP-YK-PC	Yoke	3K, 4K, 5K	5,120 – 11,360	128 -142	40, 60, 80W	100-277V	55 / 75 / 90



This area light is designed to illuminate parking areas, pathways, building facades, loading docks, and a wide variety of other large general site lighting applications. Multiple mounting options make this area light a versatile light for flood lighting, pole, ground, and wall mounted area lighting. This light series uses dip-switches to switch between three wattage and 3 CCT ranges. This area light comes with a 5 year warranty and 50,000 hours from the date of delivery to the end-user, covering light output, color stability, and driver performance.

* CCT: color temperature field selectable 3K, 4K, 5K

* Adjustable power:

- 80, 100, 150W for the 25LS-27 model
- 80, 100, 150W for the 25LS-48 model
- 150, 200, 240W for the 41LS-27 model
- 200, 240, 300W for the 51LS-27 model
- 200, 240, 300W for the 51LS-48 model

* LED chips 2835, high lumen output

* Sosen Driver

* IP65

* Long-life LEDs provide 50,000 hours of operation

* Universal 100-277 AC voltage (50-60Hz) is standard

* 277- 480V available on the AL2-25LS and AL2-51LS models

* Power factor > 0.90 - CRI > 80

* Viewing angle: Type III

* Surge protector 20KV standard

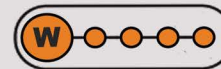

Field Selectable wattage dip switch:

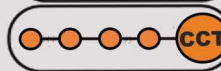

Field Selectable CCT dip switch:
3K, 4K, 5K

- * DLC 5.1 premium listed
- * UL listed for wet location
- * FCC Part 15, Class B
- * 0-10 V dimming capability is standard
- * Operating temperatures from -40°F to 122°F
- * 5-year warranty

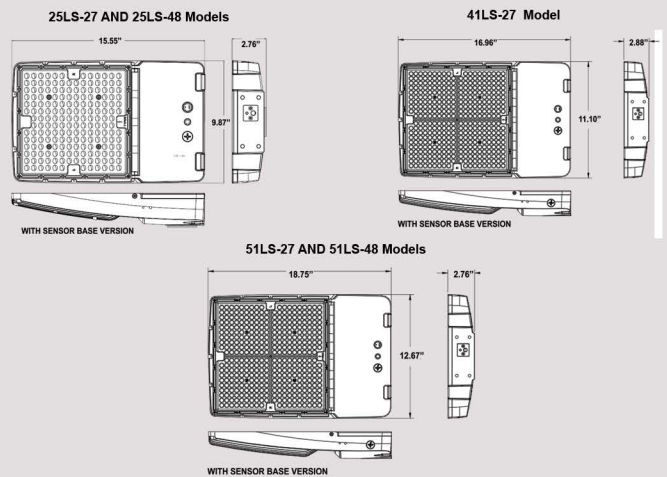

CATEGORY	PART #	DESCRIPTION	NOTE
Trunnion Mount	AL2-TR	Trunnion mount	Order the mount separately at the time of order
Direct Mount	AL2-DMT	Direct mount bracket for area light	Order the mount separately at the time of order
Slip-Fitter Mount	AL2-SF	Slip fitter mount for area light	Order the mount separately at the time of order
Sensor	ANT-5-4T	Microwave motion sensor	Order separately

PART #	CCT Color Temp	Lumens	Lumen/ watt	Wattage	Voltage
AL2-25LS-T3-27-3TCP	3K, 4K, 5K	12,888 – 25,395	150.3 – 178.3	80, 100, 150W	100-277V
AL2-25LS-T3-48-3TCP	3K, 4K, 5K	13,232 – 25,995	154.8 – 181.3	80, 100, 150W	277-480V
AL2-41LS-T3-27-3TCP	3K, 4K, 5K	23,940 – 40,464	149.5 – 176.6	150, 200, 240W	100-277V
AL2-51LS-T3-27-3TCP	3K, 4K, 5K	31,860 – 50,670	150 – 177.1	200, 240, 300W	100-277V
AL2-51LS-T3-48-3TCP	3K, 4K, 5K	32,820 – 51,900	153.8 – 180.5	200, 240, 300W	277-480V



The Legacy 2 Area light is a group of premium architectural LED lights designed to illuminate parking areas, pathways, building facades, loading docks, and a wide variety of other large general site lighting applications. Multiple mounting options make the Legacy 2 Area Light a versatile light for flood lighting, pole, ground, and wall mounted area lighting.

- * Kelvin selectable 3K, 4K, and 5K color temperature
- * Wattage selectable
- * The light distribution is field adjustable
- * 25LS-27 and 52LS-27 are 100-277 AC voltage (50-60 Hz)
- * 25LS-48 and 52LS-48 are 277-480 AC voltage (50-60 Hz)
- * Philips Lumileds LED chips and premium SOSEN driver
- * Integrated sensor receptacle
- * Die cast aluminum housing with 2 mil dark bronze powder coat
- * The light distribution is field adjustable
- * Power factor > 0.90
- * 20KV surge protector
- * EPA: 2.45 Ft2
- * 0-10V dimmable
- * Optional occupancy sensor: ANT-5-4T + ANT-5-4T-PC are sold separately

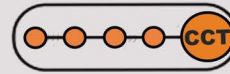

Field Selectable CCT dip switch:
3K, 4K, 5K

- * UL listed.
- * DLC premium listed.
- * IP65 "wet Location" rated.
- * Flicker free per IEEE 1789-2015 (no observable adverse effects of flicker at 100% light output level).
- * 5-year warranty on all electronics and housing.



- * Trunion and Slip-fitter mounting accessories are adjustable up to 90 Degrees in both directions
- * ANT-5-4T is a microwave motion sensor programable with RC100 remote control
- * ANT-5-4T-PC is a dusk to dawn photocell for simple on and off control

Dimensions Trunion Mount

25LS-27 / 25LS48	52LS-27 / 52LS48
A: 19.81" B: 25.29"	A: 24.18" B: 29.61"
C: 12.40" D: 6.01"	C: 15.60" D: 5.15"

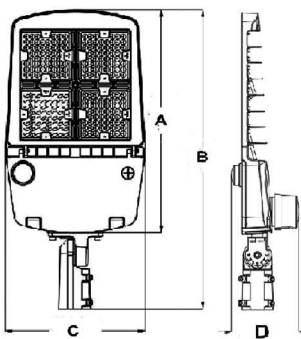

Dimensions Slip fitter
25LS-27 / 25LS48
A: 19.77" B: 26.58"
C: 12.40" D: 6.01"

Dimensions Slip fitter
52LS-27 / 52LS-48
A: 24.18" B: 31.98"
C: 15.60" D: 6.38"

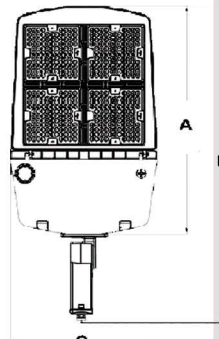

Dimensions Direct Mount
25LS-27 / 25LS48
A: 19.81" B: 19.15"
C: 12.40" D: 7.81"

Dimensions Direct Mount
52LS-27 / 52LS-48
A: 24.18" B: 31.98"
C: 15.60" D: 6.38"

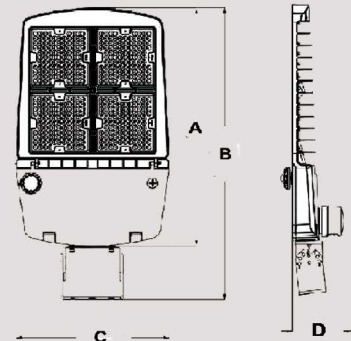

Slip fitter mount

Direct mount

Trunion mount

PART #	CCT	Lumens @ Wattage			Mounting options	Sensor Option: Sold separately
		100W	120W	150W		
CLL-LGCY2-25LS-27-CCT	3000K	15,200	18,240	22,800	Trunion Mount: CLL-LGCY-TR Direct Mount: CLL-LGCY-DMT Slip Fitter Mount: CLL-LGCY-SF	ANT-5-4T ANT-5-4T-PC
CLL-LGCY2-25LS-48-CCT	4000K	17,100	20,520	25,650		
	5000K	15,900	19,080	23,850		
		200W	240W	300W		
CLL-LGCY2-52LS-27-CCT	3000K	30,400	36,480	45,600	Trunion Mount: CLL-LGCY-TR Direct Mount: CLL-LGCY-DMT Slip Fitter Mount: CLL-LGCY-SF	ANT-5-4T ANT-5-4T-PC
CLL-LGCY2-52LS-48-CCT	4000K	34,600	41,520	51,900		
	5000K	31,800	38,160	47,700		

CANOPY LIGHTS



Low profile 70W CCT GCP1070-70W

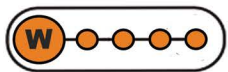

Field Selectable wattage dip switch: 40W, 60W, 70W

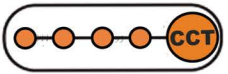

Field Selectable CCT dip switch: 3K, 4K, 5K

- * Color temperature tunable : 3K, 4K and 5K
- * Wattage selectable: 40W / 60W / 70W
- * Philips Lumileds 2835
- * Lumens: 120 Lm/W
- * 4800 Lumens at 40W; 7200 Lumens at 60W; 8400 Lm at 70W
- * Universal 100-277V AC input voltage
- * Long-life LEDs with 50,000 hours of operation
- * 0-10V dimming capability
- * Die Cast aluminium housing with durable dark bronze powder coat paint and a polycarbonate lens
- * High efficiency LED Driver and power factor > 0.90
- * Total harmonic distortion <20%
- * Color rendering Index >80
- * Dimensions: 10" x 10" x 3.41"



- * ETL listed
- * DLC listed
- * Wet location
- * -40 F to 104 F operating temperature
- * 5-year warranty on all electronics and housing

PART #	CCT Color Temp	Lumens	Lumen/watt	Wattage Selectable
GCP1070-70W-C-H-TCP	3000K	4,800	120	40W
	4000K	7,200	120	60W
	5000K	8,400	120	70W

Gas station canopy CP05-150S-UNV-850

- * Standard in 5000K
- * 100-277V AC input voltage (50-60Hz)
- * 150W provides 19,500 lumens at 130 Lu/W in 5000K
- * Die cast aluminum housing with durable white powder coat finish with at least 2 mils thick on all surfaces and a heat resistant polycarbonate lens
- * Power factor > 0.90
- * Total harmonic distortion <20%
- * Color rendering Index >80
- * Easy installation in new construction or retrofit
- * -40 F to 104 F operating temperature
- * Dimensions: 15" x 15" x 3.2"



- * UL listed
- * DLC listed
- * Wet location rated
- * 5-year warranty on all electronics and housing.

PART #	Color Temp	Lumens	Lumen/watt	Wattage
CP05-150S-UNV-850	5000K	19,500	130	150

Selectable canopy light PG07-60W

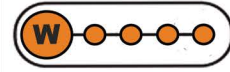

Field Selectable wattage dip switch: 30W, 45W, 60W

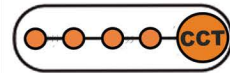

Field Selectable CCT dip switch: 3K, 4K, 5K

- * Kelvin selectable in 3K, 4K and 5K color temperature
- * Wattage selectable: 30W/45W/60W
- * Philips Lumileds 2835
- * Lumens: 131 Lm/W @ 7860 Lumens in 3K ; 145 Lm/W @ 8700 Lumens in 4K and 140 Lu/W @ 8400 Lm in 5K
- * Universal 100-277V AC input voltage
- * Dimmable with 0-10V
- * Light fixture and finish endurance tested to withstand 3000 hours of elevated ambient salt fog conditions as defined in ASTM Standard B 117
- * Die Cast aluminium housing with durable dark bronze powder coat paint. Clear stripped PC diffuser
- * High efficiency LED Driver ; Color rendering Index >80
- * Power factor > 0.90
- * Total harmonic distortion <20%
- * Dimensions: 9.5" x 9.5" x 3.62"



- * UL listed and DLC premium listed
- * IP65 rating
- * -40 F to 122 F operating temperature
- * 5-year warranty on all electronics and housing

MOTION SENSOR

- * Motion sensor UH-MMS-01 optional - sold separately

PART #	CCT Color Temp	Lumens	Lumen/watt	Wattage Selectable
PG07-60W	3000K	3,930	131	30W
	4000K	6,525	145	45W
	5000K	8,400	140	60W

GOOSENECK BARN LIGHT

BOLLARD

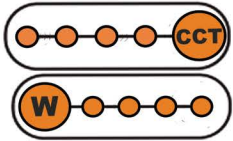

Field Selectable wattage dip switch:
15W, 20W, 25W

Field Selectable CCT dip switch:
3K, 4K and 5K

This Gooseneck Barn Light Fixture combines classic barn-style aesthetics with modern LED performance to deliver reliable, high-quality outdoor illumination. Featuring a traditional gooseneck design and durable bronze housing, this fixture offers selectable wattage 15W, 20W, 25W and 3K, 4K, 5K color temperature options for added flexibility across applications. Wide voltage compatibility and 0–10V dimming allow for seamless integration into both new and retrofit projects, making it a practical and visually appealing exterior lighting solution.

- * CCT Selectable : 3K, 4K, 5K
- * Wattage selectable: 15W / 20W / 25W
- * 0-10v Dimming
- * Lumens/watt: 130 - 3,250 Lumens @25W
- * IP65 Wet Location
- * Dusk to dawn photocell integrated
- * Universal 120-277 AC voltage (50-60Hz) is standard
- * Total harmonic distortion < 20%
- * Lighting angle: 120 degrees
- * Color rendering index > 80 Power factor >0.9
- * Operating temperatures from -40 F to 113F
- * Rotation: 270 vertical rotation
- * Die-cast aluminum housing
- * UL Listed
- * DLC Premium listed
- * FCC
- * 5-year warranty

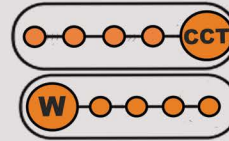
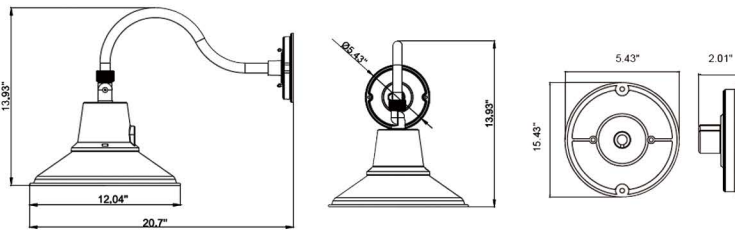

Field Selectable wattage dip switch:
12W, 18W, 24W

Field Selectable CCT dip switch:
3.5K, 4K and 5K

This contemporary Bollard adds a modern look to any pathway. This fixture is available with an integrated LED. Its industrial strength features make it DLC premium and UL Listed and suitable for wet locations. This bollard comes with a changeable CCT allowing for 3.5K, 4K or 5K settings. This bollard is designed for surface mount applications. All mounting hardware: template and anchor bolts are included.

- * CCT Selectable : 3.5K, 4K, 5K
- * Wattage selectable: 12W / 18W / 24W
- * 0-10v Dimming
- * Lumens/watt: 130 - 3,120 Lumens @ 24W
- * Lumileds 2835 Chips. UL driver
- * Available in black
- * Universal 120-277 AC voltage (50-60Hz) is standard
- * Total harmonic distortion < 20%
- * Lighting angle: 120 degrees
- * Color rendering index > 80
- * Operating temperatures from -40 F to 104 F
- * UL Listed
- * DLC Premium listed
- * 5-year warranty



CCT Temperature Selectable Switch

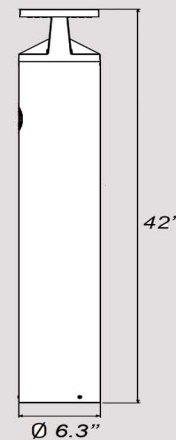

Round Shape

PART #	Color	LUMENS / WATT	LUMENS	WATTAGE SELECTALE	CCT
GSN01-25W-3CCT-ST	Bronze	130	3150	15W, 20W, 25W	3K, 4K, 5K

PART #	Color	LUMENS / WATT	LUMENS	WATTAGE SELECTALE	CCT
BR01R-4L-CCT-BLK	Black	130	3120	12/18/24	3.5K, 4K, 5K



This versatile lighting solution is ideal for illuminating parking lots, pathways, and public parks, providing bright, efficient lighting for safety and visibility. It can also be used in commercial spaces like shopping centers or campuses to enhance nighttime navigation and security. Its customizable wattage and color temperature options make it suitable for various environments, ensuring optimal performance in diverse settings. This post Top Light is designed to replace traditional metal halide lights, has high performance and an operating life of 50,000 hours while consuming more than 80% less energy. It is Wattage selectable: 50, 80, 100, 120, 150W. There are three Kelvin settings to choose from: 3K, 4K, and 5K. A universal input voltage of 100-277 AC (50-60 Hz) is standard. It comes with a die cast aluminum housing, painted black and an integrated photocell. Suitable for mounting on 2-3/8-inch posts. This Post Top light comes with a 5 year warranty.

- * CCT: 3 color temperature selectable in the field :3K, 4K, 5K
- * Wattage selectable: Field 5-way switch 50/80/100/120/150W
- * UL Listed
- * FCC Part 15, Class B
- * DLC Premium Listed
- * IP 65 Wet Rated
- * 150 lumens per watt
- * Power factor > 0.90
- * THD < 20%
- * Color rendering Index > 70
- * Long-life LEDs provide 50,000 hours of operation
- * Universal 100-277 AC voltage (50-60 Hz)
- * Heavy die-cast aluminum alloy housing with powder-coated finish
- * High quality tempered glass optics
- * Black housing, anti-salt treatment.
- * High brightness LED chips
- * Operating temperature: -4F -104F

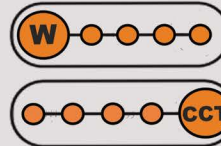

Field Selectable wattage dip switch:
50/80/100/120/150W

Field Selectable CCT dip switch:
3K, 4K and 5K

- * ETL Listed
- * DLC Premium listed
- * FCC Part 15, class B
- * IP 65 wet location
- * Operating temperatures from -4°F to 113°F
- * 5 year warranty

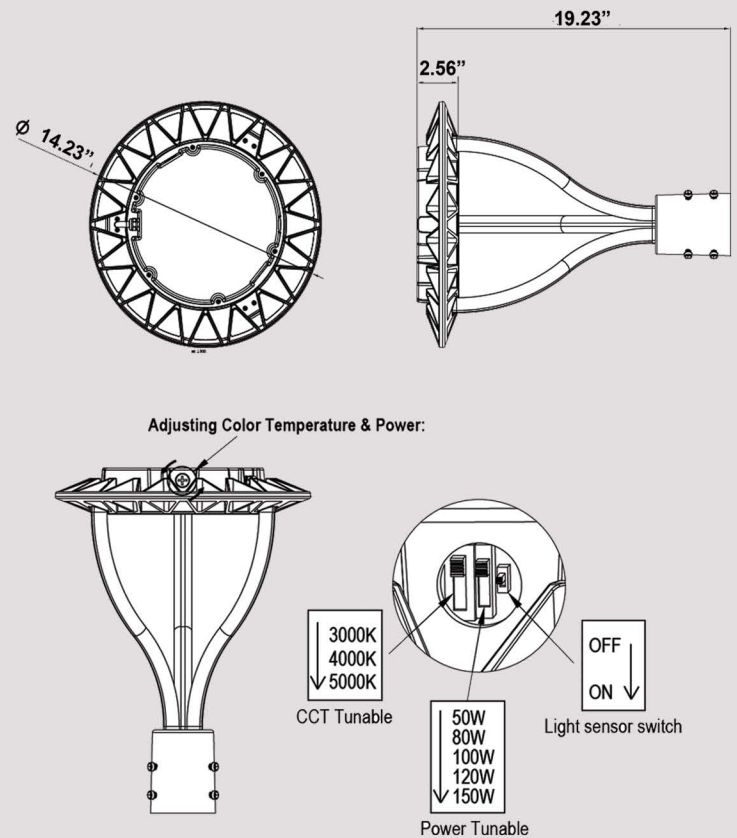

PART #	Color Temp	Lumens @ 4000K	Wattage Selectable	Lumen/w att	Voltage
SX4-150W-27-TCP-PC-BLK	3000K, 4000K, 5000K	7,500; 12,000; 15,000; 18,000; 22,500	50/ 80/100/ 120/150	150	100-277V

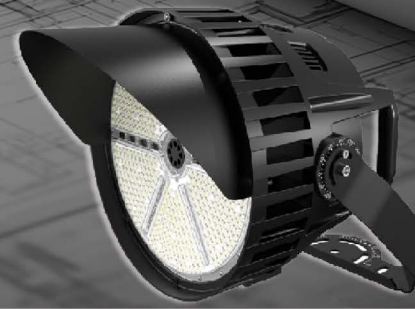

This 600W Stadium Sport Light is the top of the line in both quality and price. Lumileds LED chips and premium Sosen driver produce 96,700 Lumens. Rugged corrosion resistant die-cast aluminum housing with epoxy coating and a tough poly-carbonate prismatic lens. IP65 for all weather conditions. Come with 0-10V dimmable and rotatable bracket design, it offers versatility for any sports lighting, parking lot lighting, dock lighting, high mast flood lighting and stadium lighting.

- * UL listed
- * DLC premium
- * IP65 “wet Location” rated
- * EPA: 1.7 FT2
- * Operating temperature: -40 F to 113 F
- * Flicker free per IEEE 1789-2015 (no observable adverse effects of flicker at 100% light output level)
- * 5-year warranty on all electronics and housing



- * Color: available in 5000K
- * Up to 96,700 Lumens at 5000K / 161 Lu/W
- * Phillips Lumileds SMD2835
- * Premium Sosen Drivers
- * Long-life LEDs provide 50,000 hours of operation with at least 70% of initial lumen output (L70)
- * Universal 100-277 AC voltage (50-60Hz)
- * 277V-480V available
- * 20KV surge protection included
- * Beam Angle: >30 degrees
- * Distribution pattern: NEMA 4
- * Total harmonic distortion < 20%
- * Power factor > 0.90
- * Color rendering index > 70
- * 0-10 V dimming standard
- * Die cast aluminum housing with durable, dark bronze, powder coat paint and polycarbonate lens
- * Visor included
- * Bug rating B5-U0-G2

* Yoke mount standard, Slip fitter available (sold separately)

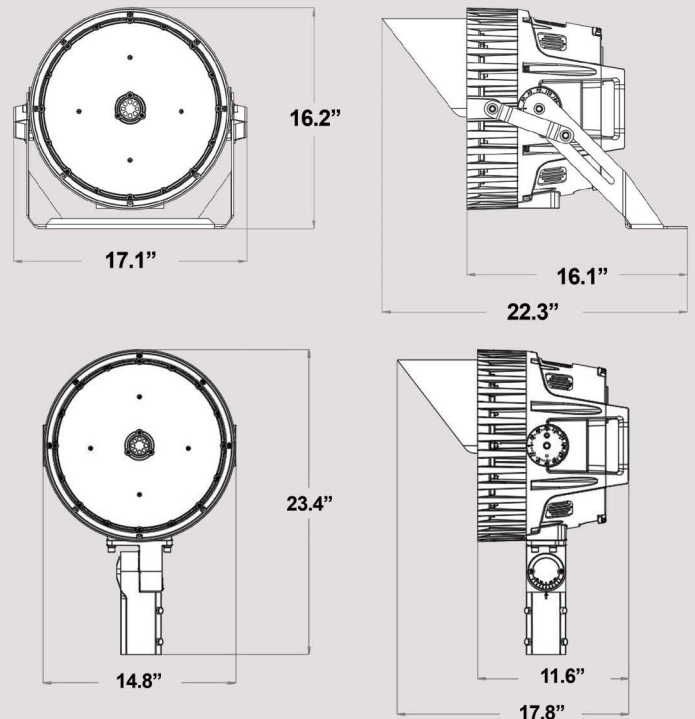

PART#	Color Temp	Lumen / watt	Lumens	Voltage	Wattage
SP16B-600W-27-5K	5000K	161	96,700	100-277V	600
SP16B-600W-48-5K	5000K	161	96,700	277-480V	600



This TWP is a series of premium, rugged, and durable LED wall packs, which are perfect for outdoor perimeter and area lighting. The housing is made of cast aluminum and powder painted in bronze polyester for a long-lasting finish. This wall pack comes standard with a 5 year warranty and a kelvin selectable switch located inside allowing users to switch between 3000K, 4000K and 5000K. Fixtures designed with an impact-resistant glass lens deliver commercial-grade durability, protecting internal LEDs from vandalism, harsh weather, and debris, while resisting the yellowing common in plastic lenses. It is also wattage selectable 30W, 40W, 60W for the TWP-60S and 80W, 100W, 120W for the TWP-120.

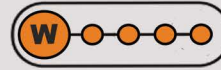

Field selectable wattage 3-way dip switch:
30, 45, 60W for the TWP60
80, 100, 120W for the TWP120

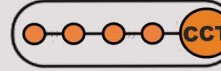

Field selectable CCT 3-way dip switch:
3K, 4K, 5K

- * DLC 5.1 premium listed
- * UL listed for wet location
- * FCC Part 15, class B
- * 5 year warranty



- * CCT: color temperature selectable 3K, 4K, 5K
- * Adjustable power: 30, 45, 60W for TWP60 wall pack
- * Adjustable power: 80, 100, 120W for the TWP120 wall pack
- * Glass lens for longer life
- * 108 to 132 lumens per watt
- * LED chips 2835, IP protected
- * Long-life LEDs provide 50,000 hours of operation
- * Universal 100-277 AC voltage (50-60Hz) is standard
- * 0-10 V dimming capability is standard
- * Operating temperatures from -40°F to 120°F
- * Power factor > 0.90
- * CRI > 80
- * Viewing angle: Type III
- * Strengthened ultra lightweight 6063 aluminum frame
- * Battery backup option available
- * Easy installation in new construction or retrofit

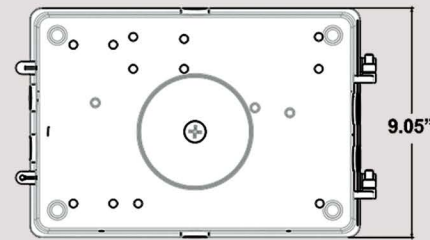
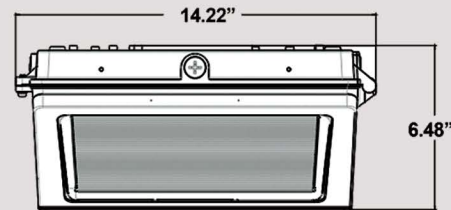

CATEGORY	PART #	DESCRIPTION	NOTE	PICTURE
EM Driver	BLD-CM20H-20W	Installed 20W Emergency Driver, IP 65 test switch indicator	Select the part number with installed EM driver	

PART #	ColorTemp	Lumens	Selectable wattage	Included	Voltage
TWP60S-27-TCP-PC	CCT 3K/4K/5K	3,819 to 8,252	30W, 40W, 60W	Photocell	120-277V
TWP120S-27-TCP-PC	CCT 3K/4K/5K	10,200 to 16,752	80W, 100W, 120W	Photocell	120-277V
TWP120S-27-TCP-PC-EM	CCT 3K/4K/5K	10,200 to 16,752	80W, 100W, 120W	Photocell	120-277V
HV-SWP11M-120W-3CCT-PC	CCT 3K/4K/5K	17,140/ 18,120/ 17,250	80W, 100W, 120W	Photocell	200-480V



LED Architectural Full cutoff wall pack provides zero uplight and low glare at high angles. Cut off lighting is designed at an angle to provide illumination that is more easily directed to a specific area. With cut off LED wall pack lights, you get illumination directly where you need it for a more concentrated output of light. It is kelvin selectable and wattage selectable. It is designed with the most powerful and efficient heat sink. It has a die cast aluminum alloy housing and anti-corrosion painting. These cut off LED wall pack lights are made with sturdy materials and the highest of manufacturing practices for a lighting solution built to last for years.

- * Kelvin Selectable in 3K, 4K, and 5K
- * Wattage selectable 40W,60W,80W
- * Long-life LEDs provide 50,000 hours of operation
- * Universal 120-277 AC voltage (50-60Hz) is standard
- * Power factor > 0.90
- * 0-10V dimming capability is standard
- * Color rendering index > 70
- * Die cast aluminum housing with durable, dark bronze, powder coat paint
- * Durable, UV-resistant polycarbonate lens
- * Removable, threaded plugs for side attachment of 1/2" rigid electrical conduit
- * Easy installation in new construction or retrofit
- * Standard with photocell pre-installed
- * Sensor base receptacle standard

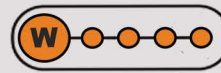

Field Selectable wattage dip switch:
40W, 60W, 80W



Field Selectable CCT dip switch:
3K, 4K, 5K,

- * UL listed
- * Wet location rated
- * Complies with FCC Part 15, class A
- * DLC Premium 5.1 Listed
- * 5-year warranty of all electronics and housing

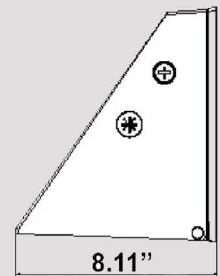
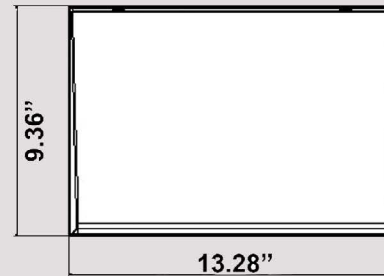

Accessory sold separately

- * Microwave motion sensor : CLL-LHB5-MS

PART #	CCT Color Temp	Lumen/watt	Selectable Wattage	Lumens
FWP06L-80W-CCT-PC-SB	3000K	137	40 / 60 / 80	5,480 / 8,220 / 10,960
	4000K	152	40 / 60 / 80	6,080 / 9,120 / 12,160
	5000K	139	40 / 60 / 80	5,560 / 8,340 / 11,120



This wattage and Kelvin selectable full cutoff adjustable wall pack is a contemporary, commercial grade area light fixture. It features a heavy-duty, spring-loaded hinge. This light has a durable die cast aluminum housing and a polycarbonate lens. This fixture is standard with photocell installed. Its housing serves as a junction box for easy install and wiring.

- * CCT selectable in 3000K, 4000K, 5000K
- * Wattage selectable 45W, 60W, 75W
- * Long-life LEDs provide 50,000 hours of operation
- * Lumens: 120 Lu/W
- * 0-10V dimming capability
- * Heavy-duty, spring-loaded hinge
- * Universal 120-277 AC voltage (50-60Hz) is standard
- * Beam angle: 65 x 95 degrees
- * Operating temperature: -40F to 113F
- * Color rendering index > 80
- * Die cast aluminum housing with durable, dark bronze, powder coat paint. better cooling, light design
- * Tough, UV-resistant polycarbonate lens
- * Photocell control standard (easily bypassed if not required)

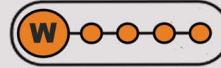

Field Selectable wattage dip switch:
45, 60, 75W

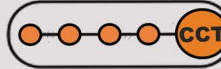

Field Selectable CCT dip switch:
3K, 4K, 5K,



- * DLC Premium listed
- * ETL Listed
- * Waterproof rating: Wet location
- * 5-year warranty on all electronics and housing

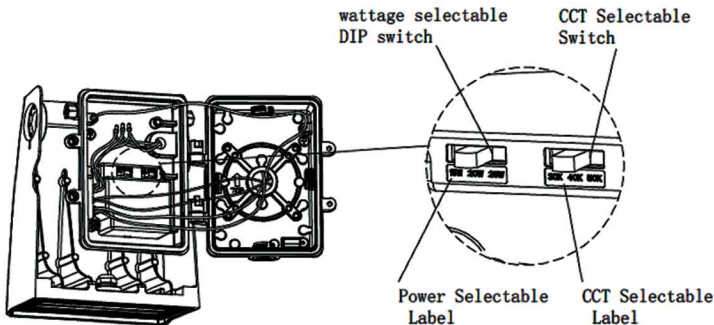
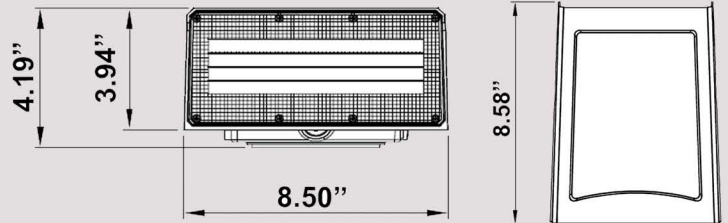

- * Heavy-duty, spring-loaded hinge provides vertical adjustability of the light housing
- * The head tilts from 0 to 90 degrees
- * Knurled notches securely retain rotated position even in harsh and rigorous environments

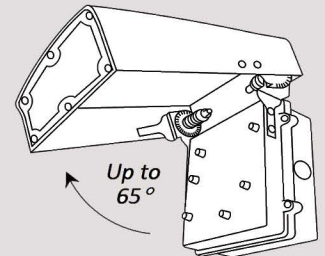

PART #	Kelvin Selectable	Lumens / Watt	Wattage Selectable	Lumens
WPD0608-75W-CCT	3000K	120 LPW	45 / 60 / 75	5,400 / 7,200 / 9,000
	4000K	128 LPW	45 / 60 / 75	5,760 / 7,680 / 9,600
	5000K	122 LPW	45 / 60 / 75	5,490 / 7,320 / 9,150



The RWP01B Series is a rugged, durable LED rotatable Wall Pack that provides full 360 adjustability of the LED modules. It is perfect for outdoor perimeter and area lighting. Featuring a die cast aluminum housing and a polycarbonate lens, the RWP01B Series will stand up to many years of harsh environmental conditions. High-efficiency, long-life LEDs provide both energy and maintenance cost savings compared to traditional MH / HID Wall Packs

- * 25W is fixed wattage but Kelvin selectable 3K, 4K, 5K
- * 80W is wattage selectable 40W, 60W, 80W and Kelvin selectable 3K, 4K, 5K
- * Lumileds SMD2835
- * Universal 120-277 AC voltage (50-60Hz) is standard
- * Beam angle: 60 degree
- * Power factor > 0.90
- * 0-10V dimming capability standard
- * Total harmonic distortion < 20%
- * Color rendering index > 80
- * Die cast aluminum housing with durable, dark bronze powder coat finish

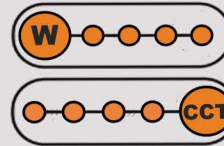

Field selectable wattage 3-way dip switch:
80W is 40W, 60W, 80W

Field Selectable CCT dip switch:
3K, 4K, 5K,

- * DLC Premium
- * UL Listed
- * Operating temperatures from (-40F to 113°F)
- * Wet Location
- * Complies with FCC Part 15, class B
- * 5-year warranty on all electronics and housing

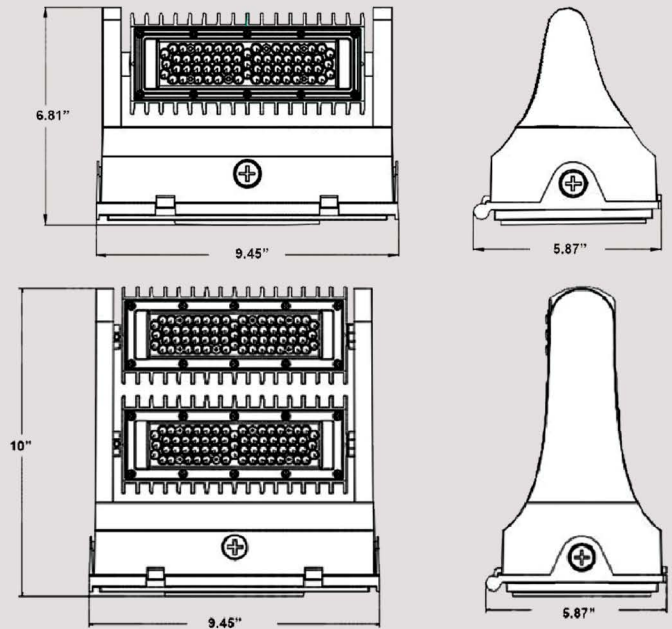

PART #	Wattage	CCT Color Temp	Lumens			Lumens per Watt		
			30K	40K	50K	30K	40K	50K
RWP01B-25W-CCT	25	30K, 40K, 50K	2,950	3,450	3,200	118	138	128
RWP01B-80W-CCT	40	30K, 40K, 50K	4,720	5,520	5,120	118	138	128
	60	30K, 40K, 50K	7,080	8,280	7,680	118	138	128
	80	30K, 40K, 50K	9,440	11,040	10,240	118	138	128

UP/DOWN CYLINDER LIGHT CCT

MINI WALL PACK

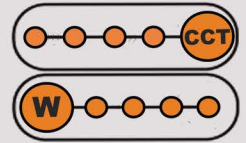
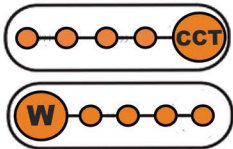
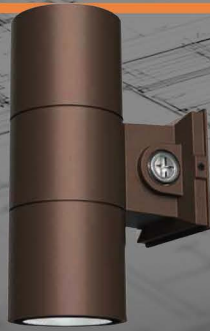

- * Color temperature CCT: 3K, 4K, 5K
- * Wattage Selectable: 22W, 29W, 35W
- * 120-277 VAC 60 Hz input voltage providing long-life LEDs with 50,000 hours of operation
- * 58 lm/W
- * 1,276 LU @ 22W - 1,682 LU @ 29W - 2,030 @ 35W
- * Power factor > 0.90
- * Color rendering Index > 80
- * Distribution pattern: 40 degrees
- * 0-10V dimming
- * IP65 rated for wet locations
- * Bronze Aluminum housing and glass lenses
- * Easy installation in new construction and retrofit
- * Total harmonic distortion <20%
- * Integrated dusk-to-dawn photocell

- * CCT: 3K, 4K, 5K
- * 121 Lu/W 3727LM @ 3000K
- * 133 Lu/W 3974 LM @4000K
- * 123 Lu/W 3803 LM @ 5000K
- * Wattage selectable: 15W Low, 20W Medium, 30W High
- * Long-life SMD285 Lumileds
- * Universal 120-277 AC voltage (50-60Hz) is standard
- * Power factor > 0.90
- * Integrated dusk to dawn photocell
- * 0-10V dimming is standard
- * Total harmonic distortion < 20%
- * Color rendering index > 80
- * Bronze powder coat
- * Polycarbonate matte lens
- * Beam angle: H105*V75 degrees
- * Easy installation in new construction or retrofit

- * UL listed for wet locations
- * Complies with FCC part 15, Class B
- * Surge immunity protection (2KV)
- * 5-year warranty of all electronics and housing



- * DLC Premium Listed
- * UL Listed
- * IP 65 rated
- * Working temperature : -40 F - 122 F
- * 5 year warranty on all electronics and housing

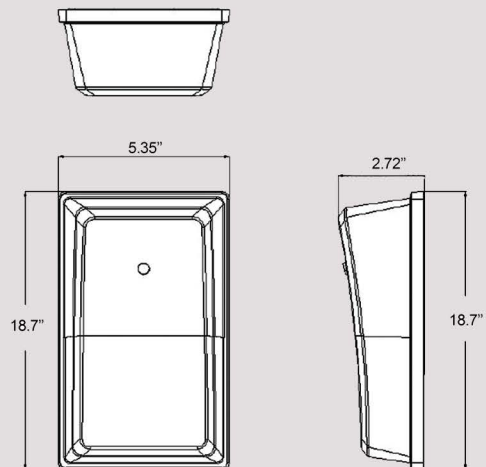
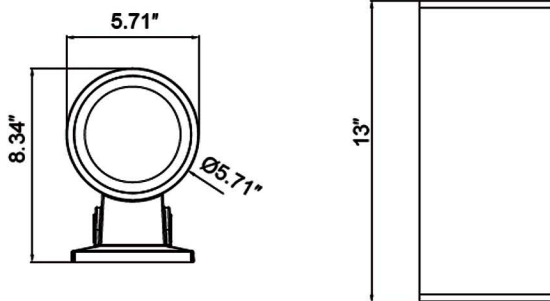

PART #	CCT	Wattage Selectable	Lumens / Watt	Total Lumens
CYL01G-35W-3CCT	3K / 4K / 5K	22W, 29W, 35W	58	1,276, 1,682, 2,030

PART #	Color Temp	Lumens	Lumen / Watt	Wattage	Voltage
MWP10B-30W-3TCP	3K, 4K, 5K	3,727 / 3,974 / 3,803	121-133	15W, 20W, 30W	AC 120-277V

SWITCHES, PLUGS AND DEVICES



IP710LFZ Single pole or 3 way switch

- * Provide single pole (one location) or 3-way (two location) lighting control when used with a 3-way switch
- * Built-in radio/TV interference filter
- * Fit easily into a standard wallbox and are suitable for multi-gang installations
- * Fluid slide movement allows fine adjustment of light level with minimal effort
- * Push button switch acts as an air gap switch completely disconnecting power from unit for bulb changing
- * Slide controls travel approximately 20mm
- * IP710-LFZ designed for use with LED fixtures using 0-10V dimming capability
- * Dual voltage 120V/277V; 28 mAmps maximum sink current.
- * Action : Standard ON/OFF
- * Series Frequency : 60 Hz - Light : None
- * Load Rating : 1200VA
- * 0-10VDC LED Power Supply



PART #	Switch Type	Load Rating	Voltage
IP710-LFZ	Single pole or 3 way install	1200VA	AC 100-277V

ELEGRP-OCS

Occupancy vacancy motion sensor light switch

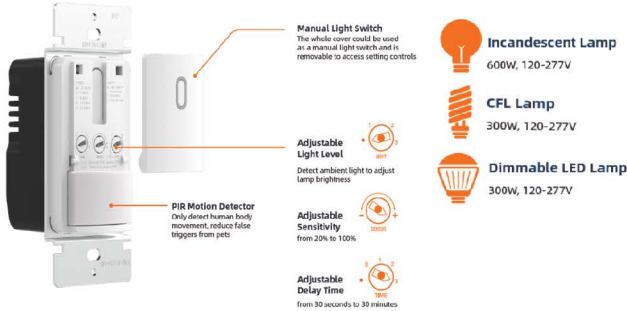

PART #	Load Rating	Voltage
ELEGRP-OCS	300W LED, CFL 600W Incandescent	AC 120-277 VAC

15 Amp / 20 Amp GFCI OUTLET

- * Tamper resistant and self test
- * GFCI outlet designed to protect against electric shock from current leaking outside of the circuit.
- * Hidden tamper resistant shutters protect against electric shock by preventing foreign objects from being inserted



ELEGRP-TRIAC-DIMMER Switch slide dimmer

- * Adjustable initial brightness setting for different type of lights
- * Compatible with 99% of light bulbs and fixtures
- * Can be used in single-pole or 3-Way applications, where lights are controlled from one or two locations. Use only one dimmer in a 3-or-4-way circuit. The other 3-or-4-way switch(es) will turn the light on at the brightness level selected at the dimmer
- * Energy savings & long operating life
- * 3 modes:
- 1: Adjust by 5% - 2: Adjust by 25% - 3: Adjust to initial brightness
- * UL & CUL listed.
- * Input Rating: 120V ,60Hz
- * Operating Temperature: -4° F to 104° F (-20° C to 40° C)
- * 1 year warranty

PART #	Load Rating	Voltage
ELEGRP-TRIAC-DIMMER	300W LED, CFL 600W Incandescent	AC 120-60Hz

ELEGRP-USB USB outlet



- * Smart Chip: Identify and optimize the charging current of your devices
- * Tamper Resistant Shutters: Prevent children from inserting any unwanted objects into the outlets.
- * Universal Compatibility: Two high speed USB ports provide the fastest charging.
- * Support side wiring and back wiring. Fits in a standard wall box. Can replace existing outlets. Compatible with standard wall plates and can be multi-ganged with other devices.
- * Extremely low standby power consumption. Energy saving and long operating life. Flame resistant material has reached the highest grade
- * Input Rating: 120 -60Hz

PART #	Load Rating	Voltage
ELEGRP-USB	15 Amp duplex USB ports Type C: 3A 5V DC Type A: 2.4A 5V DC	AC 120V-60Hz

PART #	Load Rating	Voltage
ELEGRP-GFCI-20A	20 Amp GFCI Outlet	AC 120V-60Hz
ELEGRP-GFCI-20A-WTR	20 Amp GFCI Outlet, Weather and Tamper Resistant	

CONTROLS



WP-1025 5 key wall switch

- * Powered by two CR2032 batteries (not included)
- * Transmitting distance: 200ft
- * No wires needed. Easy installation: suitable for surface-mounted or recessed in the wall
- * When low power, press any button and the red light will flash
- * Fingertip control over lights in defined zones. Linkable with one / multi zones
- * Programmable with up to 3 preset scenes
- * IP rating: waterproof IP20
- * Switch on-off, Dimming
- * 5-yr warranty



PART #	Connection	Transmitting distance
WP1025	Bluetooth	200 Feet

PPA102S Bluetooth power pack



- * Only sensor model IFS105 is compatible with PPA102S
- * Dimming: 0-10V DC
- * IP rating: waterproof IP20
- * AUX: 12V DC 200mA Max
- * For external installation with knock-out
- * UL & FCC certified
- * Input Rating: 100-277V, 60Hz
- * 360W max load



Part #	Connection	Voltage	Watt
PPA102S	Bluetooth	AC 100-277V -60Hz	360W

IFS105 Bluetooth

- * Different modes can be selected according to different applications
- * The integral photocell can switch the lights on and off for dusk to dawn control. All lighting remains on overnight even without motion detection
- * Works with PPA102S only
- * Detection range: 50ft Max
- * Mounting height: 20ft Max
- * IP rating: IP20



PART #	Voltage	Ceiling Height
IFS105	DC 12V	20 Feet

WP-4013V1 RF switch

- * Manually turn on/off and dim lights anywhere in the room
- * Quick Setup and Easy configuration for use as a handheld control or wall-mount control
- 1. Push PAIR on power pack
- 2. Push ON/OFF button for 3s to PAIR with power pack
You will hear a beep indicating the dimmer has linked with the power pack
- 3. Try the buttons to see if light is successfully controlled
- * RF range: 30meter/ 98.4 feet
- * Require 1 x CR2032 battery (not included)



PART #	RF Frequency band
WP-4013V1	443 Mhz

PPA4013SV2 RF Power pack

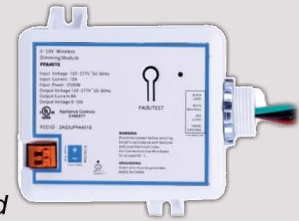

- * One dimming module can be linked with 5 RF manual control dimmers
- * Mounts through standard 1/2" knockout on electrical box
- * Standby power: 0.6W
- * Max current: 10A
- * 1200W max load
- * RF range: 30 meter/ 98.4 feet
- * Input Rating: 100-277V, 50-60Hz
- * 1200W max load
- * Frequency band: 443.92 Mhz



1/2" in 21mm trade-size knockout opening

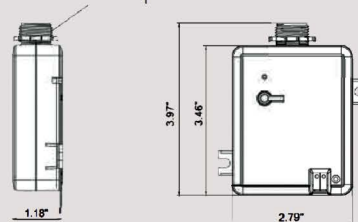

PART #	RF Frequency band	Voltage	Watt
PPA4013SV2	443 Mhz	AC 100-277V -60Hz	1200W

PHOTOCELL / MOTION SENSOR



SWTCHPC

- * Photocell sensor for traditional glass wall packs
- * Heavy-duty, weatherproof, polycarbonate housing & lens
- * Photocell is 1/2" diameter CDS (cadmium-sulfide)
- * 100-277VAC voltage (50-60Hz) is standard
- * Preset time delay
- * Contact position at night is normally closed
- * Power consumption: Below 1.5 watt average
- * Light level: ON: 9 to 1.9 FC OFF: 2.8 to 5.6FC
- * Thermal switch
- * Tungsten rating: 150W, 1.20 Amp
- * cULus listed
- * For temperatures from -40°F to 158°F, 96% relative humidity
- * 5-year warranty on all electronics and housing



PART #	Input Voltage	Rated Load	Type
SWTCHPC	120V	150W	Recessed Flush Mount

ANT-5-4T



Bi-level Microwave sensor

- * Power supply: 12V - 24V DC > 50mA
- * Time setting: 10s, 11min, 5min, 10min, 15min, 20min, 30min, 60min
- * Max Height: 40 ft - IP rating: IP 65
- * Dimmable output control: 0-10V
- * Light control: 24H, 10 LUX, 30 LUX, 50 LUX
- * Operating temp: -40°F / + 158°F
- * Optional remote available for more customizable programming

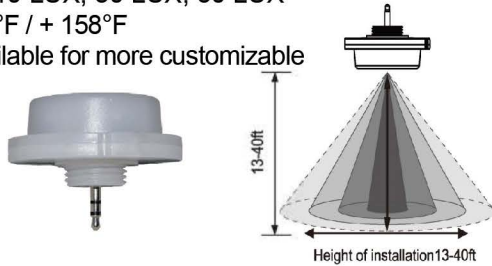

ANT-6-4T PIR sensor

Bi-level Microwave sensor

- * Power supply: 12V - 24V DC > 30mA
- * Time setting: 10 sec-60 min
- * Max Height: 50 ft - IP rating: IP 65
- * Light control: 10-50 LUX
- * Operating temp: -4°F / + 140°F

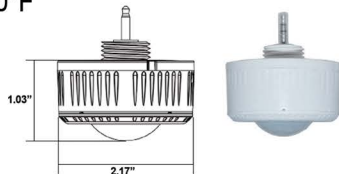

PENPC

- * Control light sources including LED incandescent, HID, and fluorescent
- * Heavy-duty, rain-proof, polycarbonate housing and lens
- * Photocell is 1/2" diameter CdS (cadmium-sulfide)
- * Universal 120-277AC voltage (50-60Hz) is standard
- * Preset time-delay prevents unintended switching due to momentary flashes of light
- * Power consumption: 2 watts
- * Switches light source on when ambient lighting levels decrease to 1-2 foot-candles and off when ambient light increase to 3-8 foot candles
- * cULus listed
- * For temperatures from -40°F to 158°F, 99% relative humidity
- * 5-year warranty on all electronics and housing

PART #	Input Voltage	Swivel	Type	Rated Load	Power Leads
PENPC	120V-277V	0-200	Pencil	1,800W	16 AWG, 302 F, 6"



ANT-5-4T-PC



Bi-level Microwave sensor Photocell only

- * Power supply: 12V - 24V DC > 50mA
- * On / off only
- * Not programmable
- * IP rating: IP 65
- * Operating temp: -40°F / + 158°F
- * Dusk to Dawn



PART #	Input Voltage	Max Height	Usage
ANT-5-4T	12-24V	40FT	High Bay Lights
ANT-5-4T-PC	12-24V	40FT	High Bay Lights
ANT-6-4T-PIR	12-24V	50FT	High Bay Lights

WALL MOUNTS

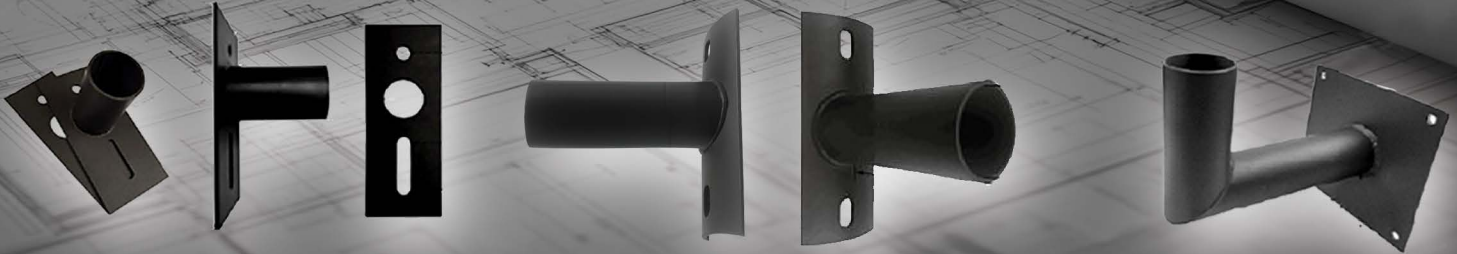

ADP2.5-D

Horizontal Slip Fitter Adaptor

2-3/8" OD Horizontal Tenon Bracket is designed to mount light fixtures that are equipped with an adjustable slip-fitter onto a standard 2-3/8" OD horizontal tenon.

ADP2.5-BAR5-D

Horizontal Tenon Arc Adaptor

2-3/8" OD Horizontal Tenon Mid-Pole Bracket is designed to mount light fixture that is equipped with an adjustable slip-fitter onto a round pole.

ADP2.5-90-D

Wall Mount 90° Tenon Adapter Square

The 90° wall mount bracket with 2-3/8" tenon attaches flood and area light fixtures to almost any surface: wall, roof or wood pole. Provides wiring access and a built-in 2-3/8" O.D. tenon to mount a fixture with an adjustable slip-fitter. Suggested 3/8" diameter bolts for mounting. Mounting holes are spaced 3-1/4" apart.



ADP2.5-90H-D



ADP2.5-180H-D

Wall Mount 90° Tenon Adapter Horizontal

The 90° wall mount bracket with 2-3/8" O.D tenon attaches flood and area light fixtures to almost any surface: wall, roof or wood pole. Provides wiring access and a built-in 2-3/8" O.D. tenon to mount a fixture with an adjustable slip-fitter.

Double 180° Wall Mount Bracket with 2-3/8" O.D. Tenon

The 180° wall mount bracket with 2-3/8" tenon attaches two flood or area light fixtures to almost any surface: wall, roof or wood pole. Provides wiring access and a built-in 2-3/8" O.D. tenon to mount a fixture with adjustable slip-fitter. Suggested 3/8" diameter bolts for mounting. Mounting holes are spaced 3-1/4" apart.

PART #	Description
ADP2.5-D	Wall Mount Horizontal Tenon Adapter
ADP2.5-BAR5-D	2-3/8" OD Horizontal Tenon Arc Adaptor
ADP2.5-90-D	Wall Mount 90° Bracket Square
ADP2.5-90H-D	Wall Mount 90° Bracket Horizontal
ADP2.5-180H-D	Double 180° Wall Mount Bracket with 2-3/8" OD Tenon

TENONS

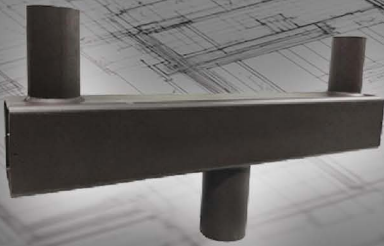

VTS4R-2T-D

Low Profile Double Tenon Adapter

The Bracket is designed to mount over a standard 2-3/8" O.D. vertical tenon. Two fixtures can be mounted to the two round 2-3/8" O.D tenons on top can be adjusted accordingly.

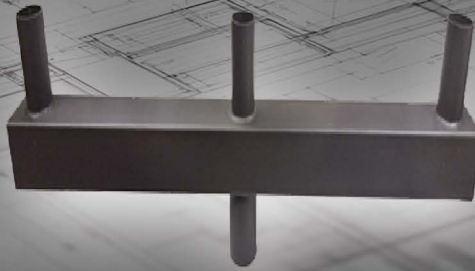

VTS4R-3T-D

Low Profile Triple Tenon Adapter

The Bracket is designed to mount over 2-3/8" O.D. vertical tenon. Three fixtures can be mounted to the three round 2-3/8" O.D tenons on top can be adjusted accordingly.



VTS4R-4T-D

Low Profile Quad Tenon Adapter

The Bracket is designed to mount over 2-3/8" O.D. vertical tenon. Four fixtures can be mounted to the four round 2-3/8" O.D tenons on top can be adjusted accordingly.



QT120-3T-D

Low Profile Triple 120° Tenon Adaptor

The Bracket is designed to mount over a 2-3/8" O.D. vertical tenon. Three fixtures can be mounted to the three round 2-3/8" O.D tenons on top can be adjusted accordingly.

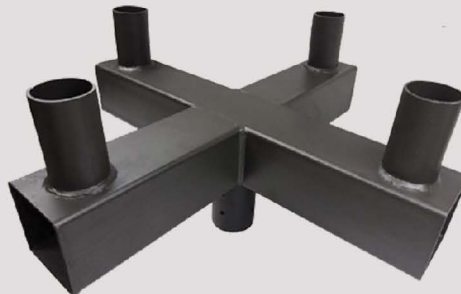

QT90-4T-D

Low Profile Quad 90° Tenon Adaptor

The Bracket is designed to mount over a 2-3/8" O.D. vertical tenon. Four fixtures can be mounted to the four round 2-3/8" O.D tenons on top can be adjusted accordingly.



VTS4-D

Square Tenon Adaptor 4 inch

For use with 4" square, non-tapered steel and aluminum poles. Furnished with four 5/16" hex head stainless-steel bolts. Vertical tenon measures 2-3/8" O.D., and is made of steel galvanized tubing. Fixture mounted to this bracket can be adjusted vertically and also rotated horizontally.

PART #	Description
VTS4R-2T-D	Low Profile Double Tenon Adapter
VTS4R-3T-D	Low Profile Bullhorn with 3 Tenons
VTS4R-4T-D	Low Profile Bullhorn with 4 Tenons
QT120-3T-D	Low Profile Triple Tenon Adapter
QT90-4T-D	Low Profile Quad Tenon Adapter
VTS4-D	Square Tenon Adapter 4 inch
VTS5-D	Square Tenon Adapter 5 inch

VTS5-D

Square Tenon Adaptor 5 inch

For use with 5" square, non-tapered steel and aluminum poles. Furnished with four 5/16" hex head stainless-steel bolts. Vertical tenon measures 2-3/8" O.D., and is made of steel galvanized tubing. Fixture mounted to this bracket can be adjusted vertically and also rotated horizontally.

SPOKES



SB2.5S90-D

Single Spoke Bracket

The Bracket is designed to mount over a round 2-3/8" (60mm) tenon. One fixture can be mounted to the round 2-3/8" O.D horizontal tenon and can be adjusted accordingly.



SB2.5TW180-D

Twin Spoke Bracket 180° Arms

The Bracket is designed to mount over a round 2-3/8" (60mm) O.D. round vertical tenon. Two fixtures can be mounted to the round external mount and can be adjusted accordingly.



SB2.5TW90-D

Twin Spoke Bracket 90° Arms

The Bracket is designed to mount over 2-3/8" (60mm) O.D. round vertical tenon. Two fixtures can be mounted to the round external mount and can be rotated adjusted accordingly.

SB2.5TR120-D



Triple Spoke Bracket 120° Arms

The Bracket is designed to mount over 2-3/8" (60mm) O.D. round vertical tenon. Three fixtures can be mounted to the round external mount and can be rotated adjusted accordingly.

SB2.5QD90-D



Quad Spoke Bracket 90° Arms

The Bracket is designed to mount over 2-3/8" round (60mm) O.D. vertical tenon. Four fixtures can be mounted to the round external mount and can be rotated adjusted accordingly.

PART #	Description
SB2.5S90-D	Single Spoke Bracket
SB2.5TW180-D	Twin Spoke Bracket 180° Arms
SB2.5TW90-D	Twin Spoke Bracket 90° Arms
SB2.5TR120-D	Triple Spoke Bracket 120° Arms
SB2.5QD90-D	Quad Spoke Bracket 90° Arms

BULL HORNS AND ADAPTERS



RB2.5D180-D

180° Double Bullhorn

The Bracket is designed to mount over a round 2-3/8" (60mm) O.D. vertical tenon. Two fixtures can be mounted to the Round External Mount vertical Tenons and adjusted accordingly.

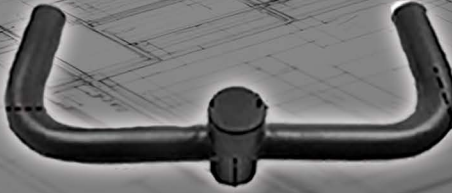

RB2.5TR180H-D

Horizontal 180° Double Bullhorn

The Bracket is designed to mount over a round 2-3/8" (60mm) O.D. vertical tenon. Two fixtures can be mounted to the round 2-3/8" O.D horizontal tenons and can be adjusted accordingly.



RB2.5TR180-D

180° Triple Bullhorn

The Bracket is designed to mount over a 2-3/8" O.D. vertical tenon. Three fixtures can be mounted to the round 2-3/8" O.D tenons and can be rotated vertically and horizontally.



RB2.5QD90-D

90° Quad Bullhorn

The Bracket is designed to mount over a 2-3/8" (60mm) O.D. vertical tenon. Four fixtures can be mounted to the round 2-3/8" O.D tenons and can be rotated vertically and horizontally.



RB2.5TR180-4T-D

180° Quad Bullhorn

The Bracket is designed to mount over 2-3/8" O.D. vertical tenon. Four fixtures can be mounted to the round 2-3/8" O.D tenons and can be rotated vertically and horizontally.

PART #	Description
RB2.5D180-D	180° Double Bullhorn
RB2.5TR180H-D	Horizontal 180° Double Bullhorn
RB2.5TR180-D	180° Triple Bullhorn
RB2.5QD90-D	90° Quad Bullhorn
RB2.5TR180-4T-D	180° Quad Bullhorn

PART #	Description
VT3-D	Round Tenon Adapter 3"
VT4-D	Round Tenon Adapter 4"
VT5-D	Round Tenon Adapter 5"



VT3-D

Round Tenon Adapter 3 inch

For use with 3" Round, non-tapered steel and aluminum poles. Furnished with three 3/8" hex head stainless-steel bolts. Vertical tenon measures 2-3/8" O.D. tenon and is made of steel tubing. The fixture mounted to this bracket can be adjusted both vertically and also rotated horizontally.



VT4-D

Round Tenon Adapter 4 inch

For use with 4" Round, non-tapered steel and aluminum poles. Furnished with three 3/8" hex head stainless-steel bolts. Vertical tenon measures 2-3/8" O.D. round and is made of steel tubing. The fixtures mounted to this bracket can be adjusted both vertically and also rotated horizontally.



VT5-D

Round Tenon Adapter 5 inch

For use with 5" Round, non-tapered steel and aluminum poles. Furnished with three 3/8" hex head stainless-steel bolts. Vertical tenon measures 2-3/8" O.D. round and is made of steel tubing. The fixtures mounted to this bracket can be adjusted both vertically and also rotated horizontally.

STRAIGHT SQUARE AND STRAIGHT ROUND POLES

All our poles are

Galvanized
inside + out

All our poles are built from high strength steel tube and are standard side drilled for arm mount.

Specifications and Features: Conforms to ASTM-A 500 Grade B: Minimum yield strength of 46,000 PSI.

Finish: Textured architectural bronze powder coat finish, baked to ensure maximum paint adhesion, hardness and durability.

Straight Square Poles

Mounting options: 10Ft and 15Ft

Note: When using Arm or Slip-Fitter Mounts, additional installation parts may be required to ensure proper installation, such as a pole cap.

Mounting options PMPF models: 20Ft, 25Ft and 30Ft

Included standard with each pole are rubber fitted cap / rain guard, and hole plugs for unused mounting holes. All poles are drilled at 90 degrees for side mounting hardware. If tenon installation is needed, VT4 and VT5 tenon adapters available (sold separately).

Includes: J-Bolts, set plate, nuts and washers, base cover, tenon top 10Ft & 15Ft, pole cap on 20Ft, 25Ft, 30Ft

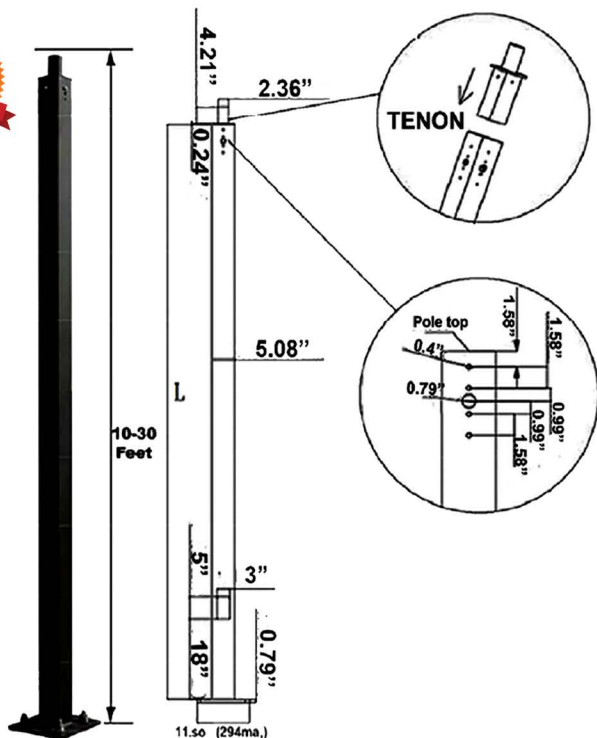

Specification type	Height	Wall thickness	Shaft base	Base size	Bolt circle	Bolt projection
10FT4-D-T	10 Ft	11 Gauge	4x4 in	11 in	8-11 in	2.75 in
15FT4-D-T	15 Ft	11 Gauge	4x4 in	11 in	8-11 in	2.75 in
PMPF-20FT4-11GA-BNZ	20 Ft	11 Gauge	4x4 in	11 in	8-11 in	2.75 in
PMPF-25FT4-11GA-BNZ	25 Ft	11 Gauge	4x4 in	11 in	8-11 in	2.75 in
PMPF-30FT5-11GA-BNZ	30 Ft	11 Gauge	5x5 in	11 in	8-11 in	2.75 in

Straight Round Poles

Mounting options

Side mount: Standard length poles are predrilled (2@180°), with a polycarbonate top cover and hole plugs for unused pre-drilled locations.

Note: When using Arm or Slip-Fitter Mounts, additional installation parts may be required to ensure proper installation.

Top mount Round Pole Tenon Adapters (optional) can be installed for a use with a Slip-Fitter or Multi-Fixture installation requiring Bullhorns, Spokes etc.

(3"RND, 4"RND, and 5"RND to 2-3/8" Round Tenon Adapters available)

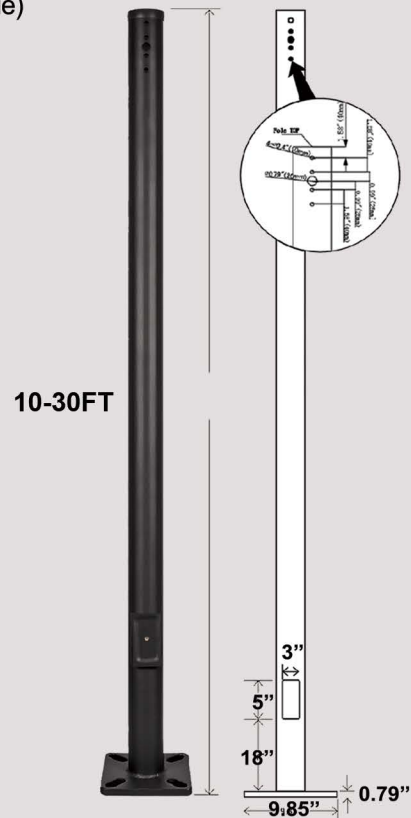

Specification type	Height	Wall thickness	Shaft base	Weight (LBS)
R10FT3-11G-D	10 Ft	11 Gauge	3" dia	72
R15FT4-11G-D	15 Ft	11 Gauge	4" dia	95
R20FT4-11G-D	20 Ft	11 Gauge	4" dia	149
R25FT4-11G-D	25 Ft	11 Gauge	4" dia	176
R30FT5-11G-D	30 Ft	11 Gauge	5" dia	242

DIRECT BURIAL SQUARE AND ROUND POLES

All our poles are

Galvanized
inside + out

All our poles are built from high strength steel tube and are standard side drilled for arm mount.

Specifications and Features: Conforms to ASTM-A 500 Grade B: Minimum yield strength of 46,000 PSI.

Finish: Textured architectural bronze powder coat finish, baked to ensure maximum paint adhesion, hardness and durability.

Direct Burial Square Poles 10Ft, 15Ft and 20Ft

Mounting options

Note: When using Arm or Slip-Fitter Mounts, additional installation parts may be required to ensure proper installation. Direct burial standard with tenon adapter.

Top mount: Installing ARM (optional) will need to take-off the Tenon standard package and put rain cover on top.

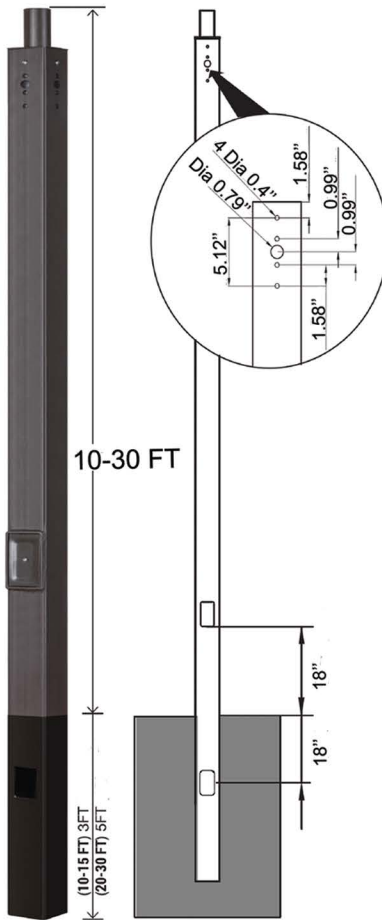

Part #	Height	Wall thickness	Shaft base	Subsurface depth	Size
DBS10FT4-11G-D-T	10 Ft	11 Gauge	4"x 4"	3ft	4" x 4"
DBS15FT4-11G-D-T	15 Ft	11 Gauge	4"x 4"	3ft	4" x 4"
DBS20FT4-11G-D-T	20 Ft	11 Gauge	4"x 4"	5ft	4" x 4"

Direct Burial Round Poles 10Ft, 15Ft and 20Ft

Mounting options

Note: When using Arm or Slip-Fitter Mounts, additional installation parts may be required to ensure proper installation. Direct burial standard with tenon adapter.

Top mount: Installing ARM (optional) will need to take-off the Tenon standard package and put rain cover on top.

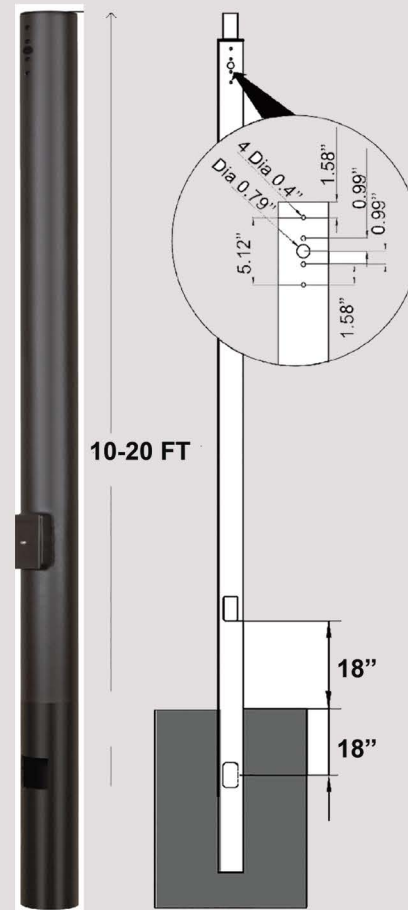

Part #	Height	Wall thickness	Shaft base	Subsurface depth	Size
DBR10FT4-11G-D-T	10 Ft	11 Gauge	4"	3ft	4"
DBR15FT4-11G-D-T	15 Ft	11 Gauge	4"	3ft	4"
DBR20FT4-11G-D-T	20 Ft	11 Gauge	4"	5ft	4"

TAPERED ROUND POLES & TOP POST POLES

All our poles are

Galvanized
inside + out

All our poles are built from high strength steel tube and are standard side drilled for arm mount.

Specifications and Features: Conforms to ASTM-A 500 Grade B: Minimum yield strength of 46,000 PSI.

Finish: Textured architectural bronze powder coat finish, baked to ensure maximum paint adhesion, hardness and durability.

Direct Burial Top Post Pole Black

Mounting options

Note: 3" x 15' pole, 12' above grade Direct Burial Straight Round pole, 3' below grade, with a 2 3/8" tenon on top. Made specifically for our **post top lights** as a combo. Black



15' pole 3" diameter

Tapered Round Poles 20Ft, 25Ft and 30Ft

Mounting options

Note: When using Arm or Slip-Fitter Mounts, additional installation parts may be required to ensure proper installation. (example: with Slip-fitter a bullhorn will be the option)

Side mount: Standard length poles are predrilled (2@180°), with a polycarbonate top cover and hole plugs for unused predrilled locations.

Top mount: Round Pole Tenon Adapters (Optional) can be installed for a use with a Slip-Fitter or Multi-Fixture installation requiring Bullhorns, Spokes etc. (4"RND to 2 3/8" Round Tenon Adapters available).

Includes: J-Bolts, set plate, nuts and washers, base cover and top cap

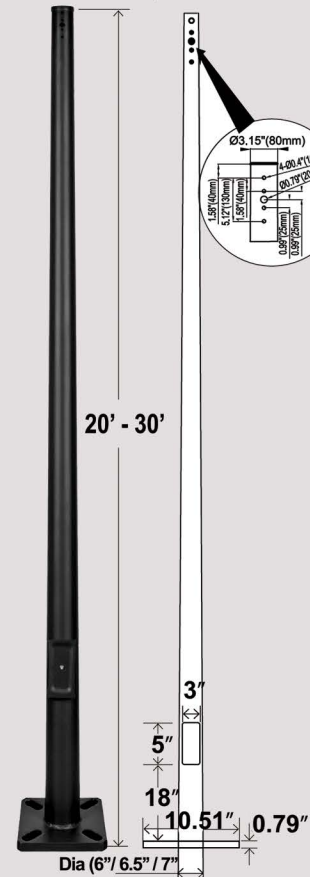

Part #	Height	Wall thickness	Shaft base	Subsurface depth
RDB12FT3-11G-BLK	12	11 Gauge	3"	3 ft

Specification type	Height	Wall thickness	Shaft base	Weight (LBS)
TPR20FT6-11G-D	20 Ft	11 Gauge	6" dia	123
TPR25FT6.5-11G-D	25 Ft	11 Gauge	6.5" dia	163
TPR30FT7-7G-D	30 Ft	7 Gauge	7" dia	300

CONVERSION CHART



Existing
MH, CFL, HPS, HID

175W =



Shoebox

45W or 5,850 lumens

250W =



Wall pack

60W or 7,800 lumens

400W =

750W =



UFO

150W or 19,500 lumens

200W or 29,000 lumens

1,000W =

1,250W =

300W or 39,000 lumens

400W or 51,000 lumens

1,500W =



Linear high bay

450W or 58,000 lumens

1,800W =

600W or 80,000 lumens



D-TEC LED LLC

13375 N. Stemmons Frwy

Suite 110

Farmers Branch, TX 75234

Tel: 972-290-0149

e-Mail: sales@dteclcd.com

www.dteclcd.com
